

# FEFCO2

## Mudel nr 0200

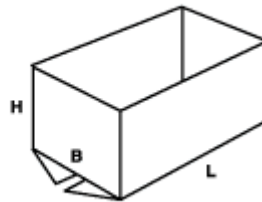

## Mudel nr 0201

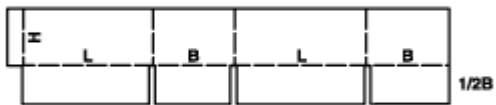
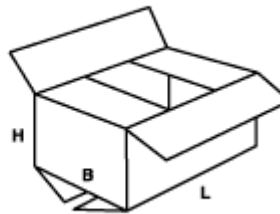
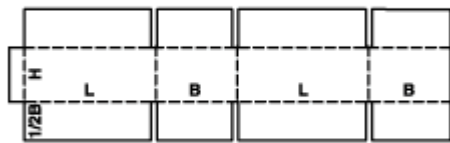

## Mudel nr 0202

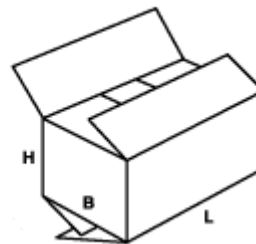
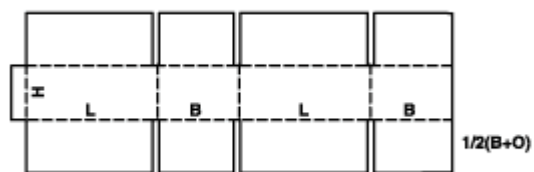

### Mudel nr 0203

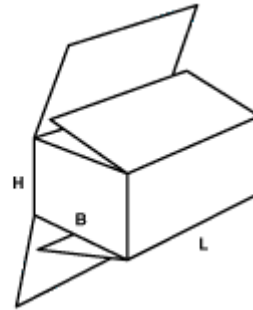
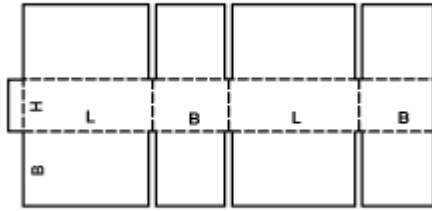

### Mudel nr 0204

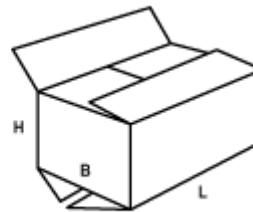
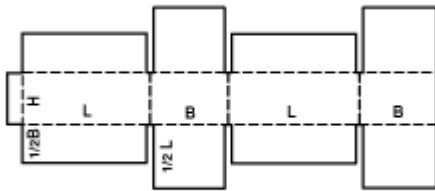

### Mudel nr 0205

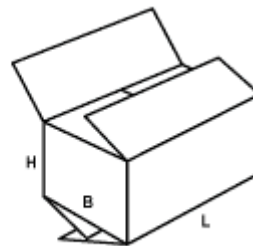
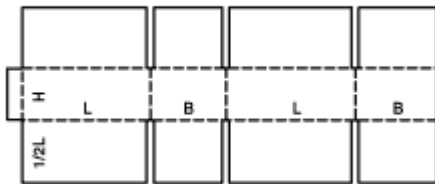

## Mudel nr 0206

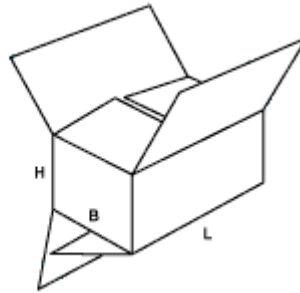
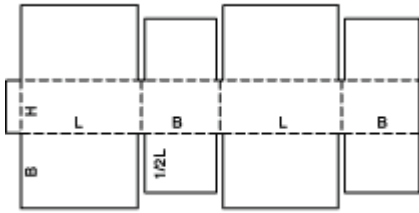

## Mudel nr 0207

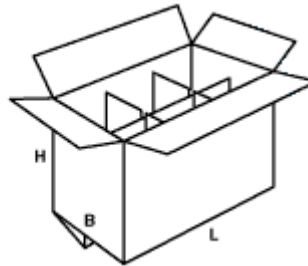
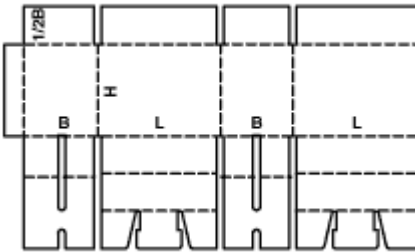

## Mudel nr 0208

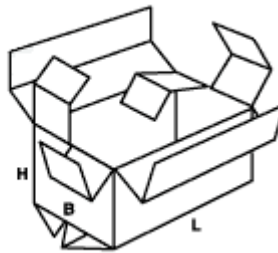
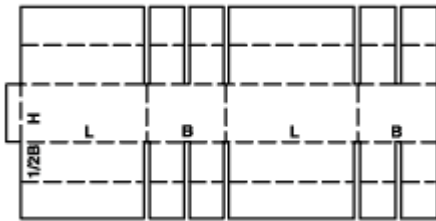

## Mudel nr 0209

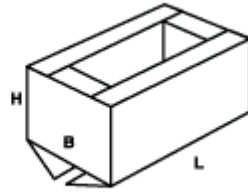
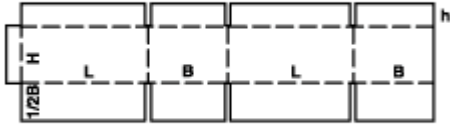

## Mudel nr 0210

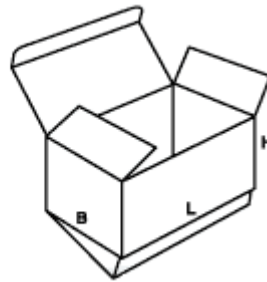
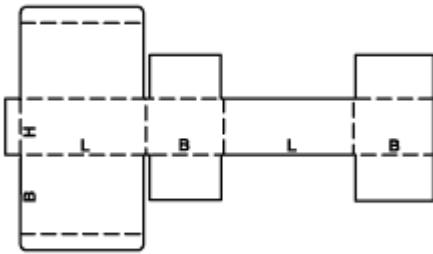

## Mudel nr 0211

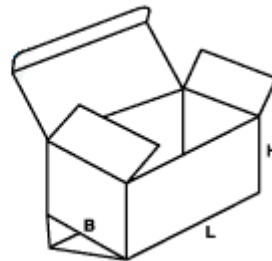
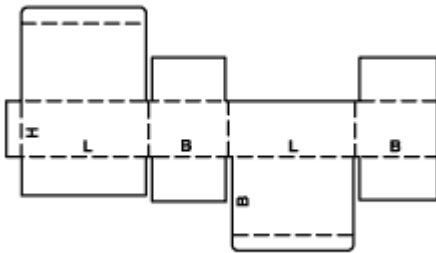

## Mudel nr 0212

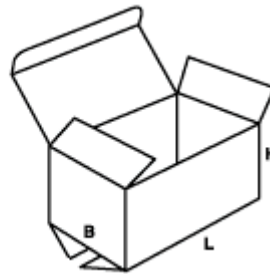
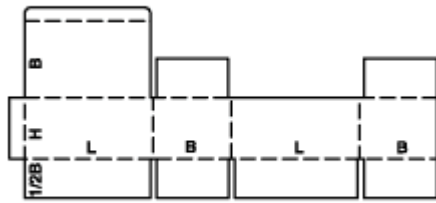

## Mudel nr 0214

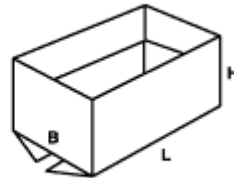
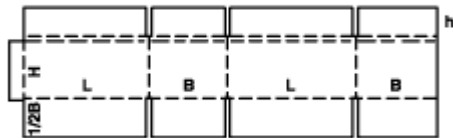

## Mudel nr 0215

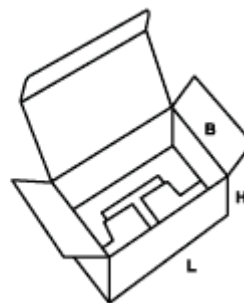
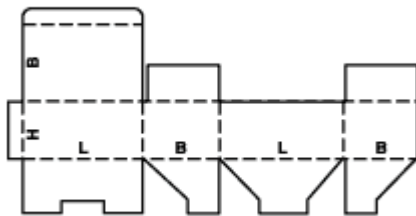

## Mudel nr 0216

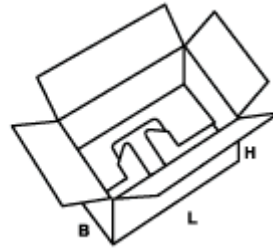
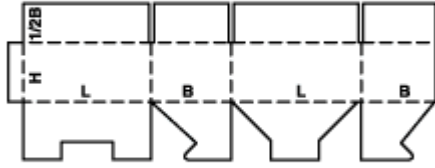

## Mudel nr 0217

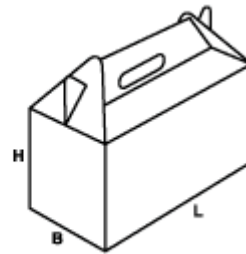
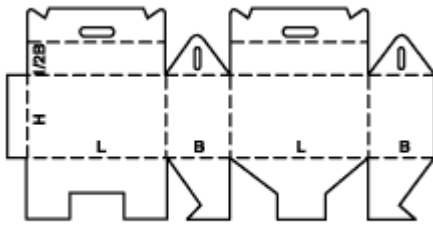

## Mudel nr 0218

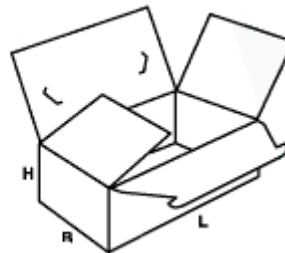
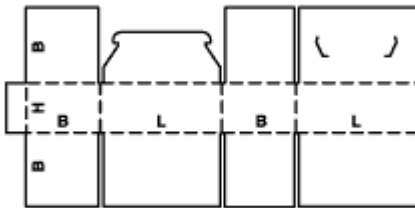

## Mudel nr 0225

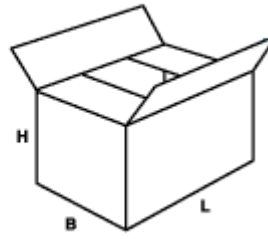
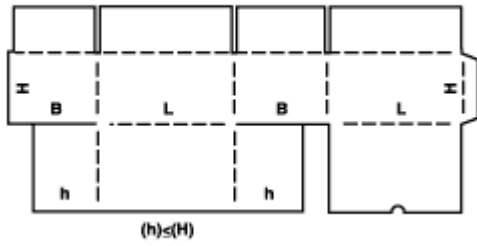

## Mudel nr 0226

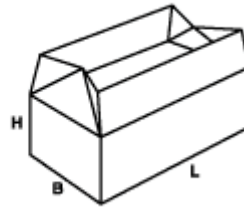
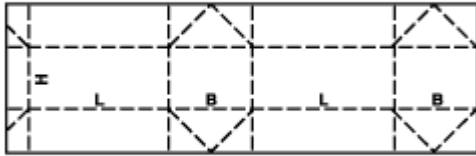

## Mudel nr 0227

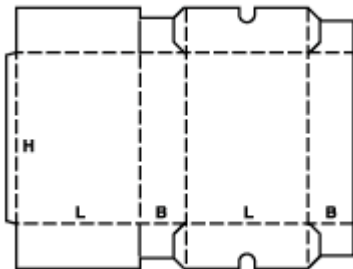

### Mudel nr 0228

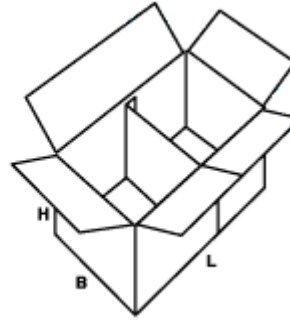
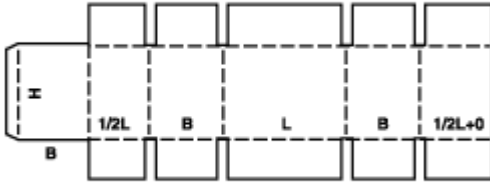

### Mudel nr 0229

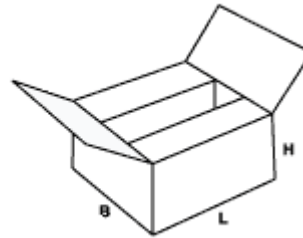
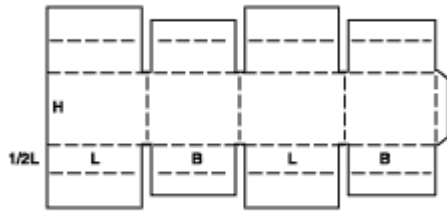

### Mudel nr 0230

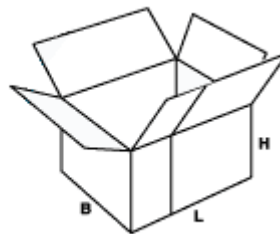
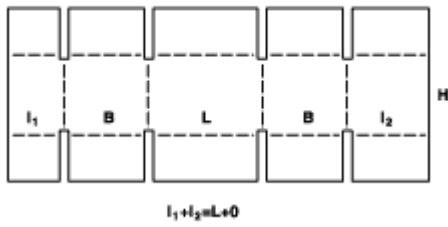



## Mudel nr 0231

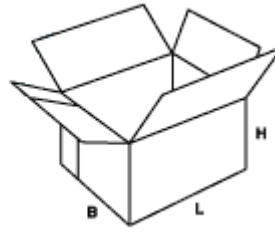
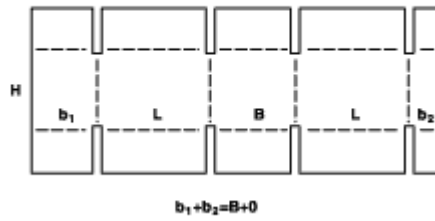

## FEFCO3

### Mudel nr 0300

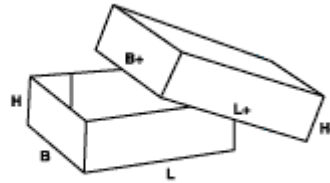
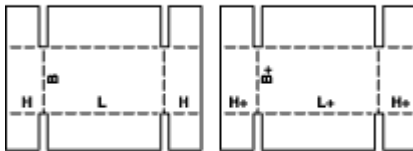

### Mudel nr 0301

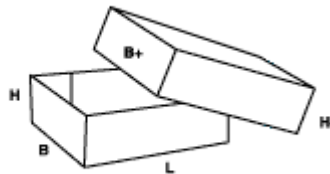

## Mudel nr 0302

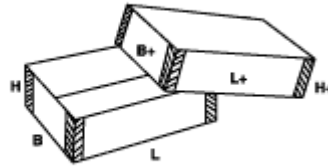
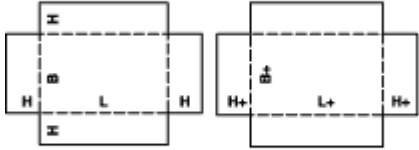

## Mudel nr 0303

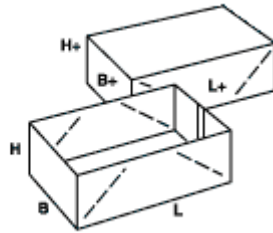
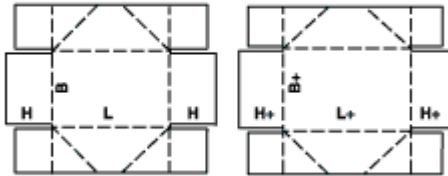

## Mudel nr 0304

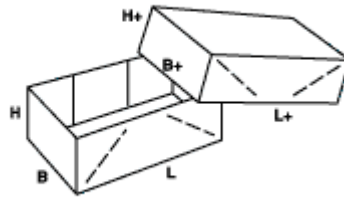
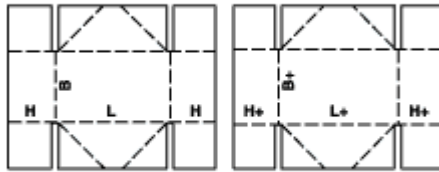

## Mudel nr 0305

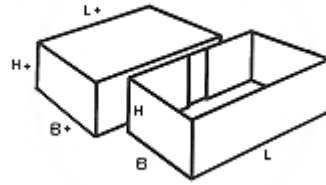
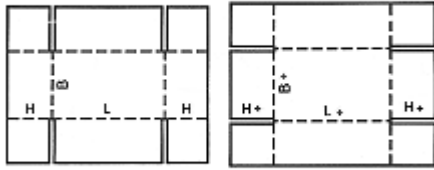

## Mudel nr 0306

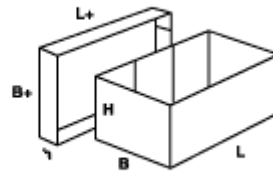
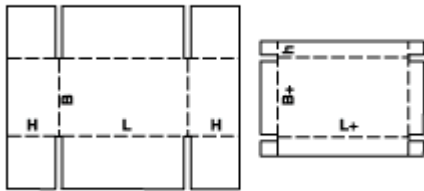

## Mudel nr 0307

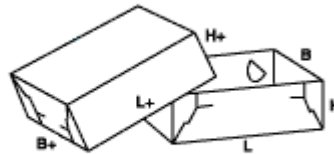
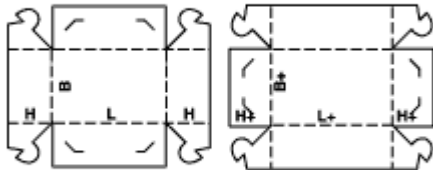

## Mudel nr 0308

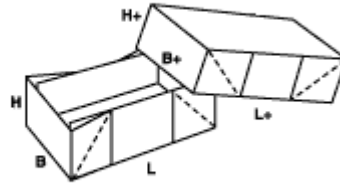
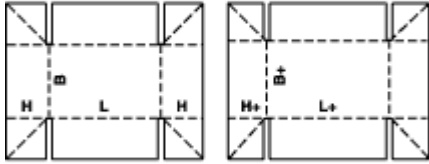

## Mudel nr 0309

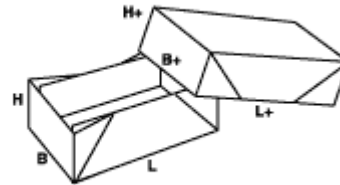
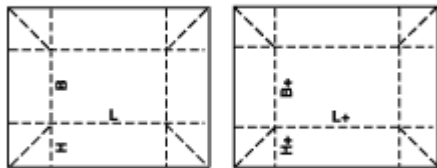

## Mudel nr 0310

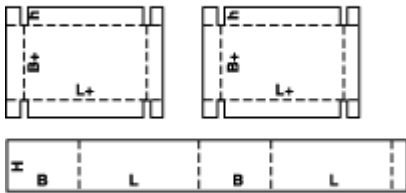

$$h < \frac{1}{2} H+$$

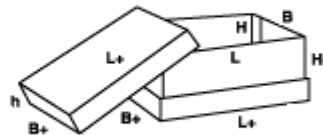

## Mudel nr 0311

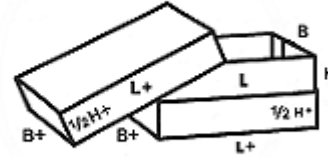
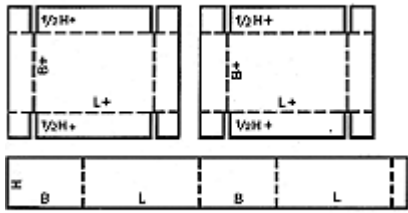

## Mudel nr 0312

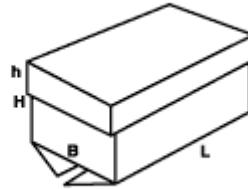
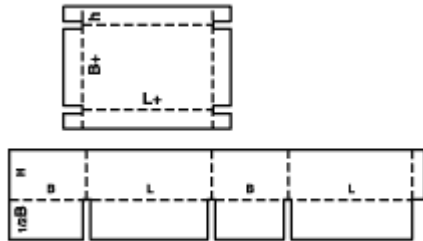

## Mudel nr 0313

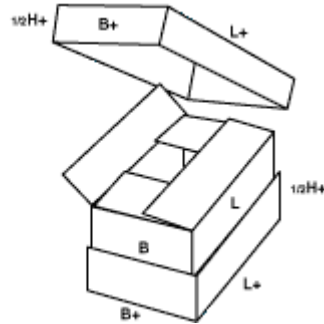
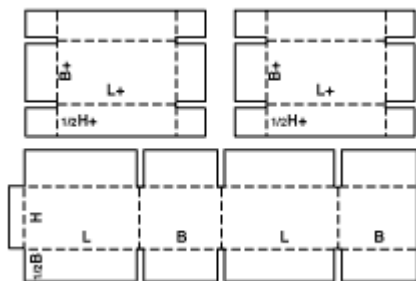

## Mudel nr 0314

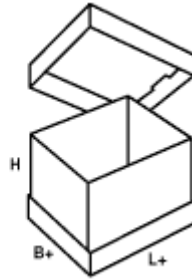
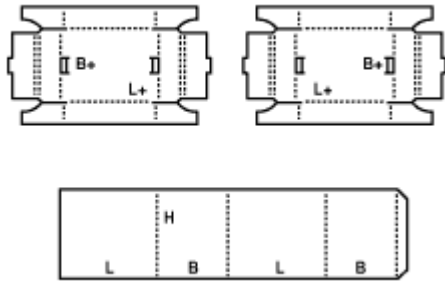

## Mudel nr 0320

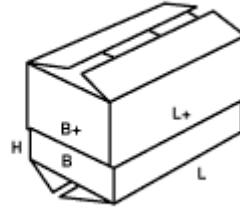

## Mudel nr 0321

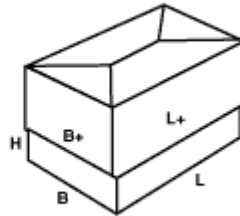
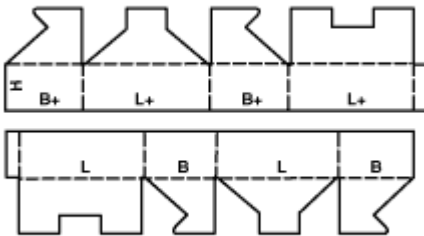

### Mudel nr 0322

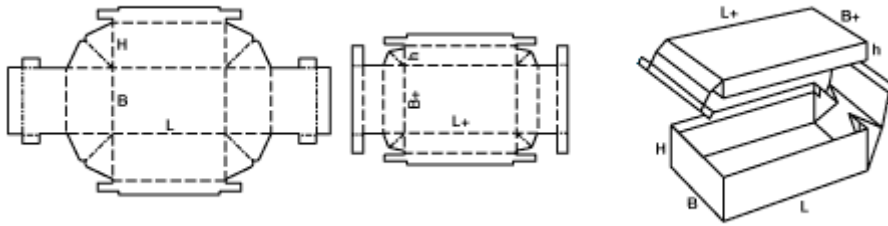

### Mudel nr 0323

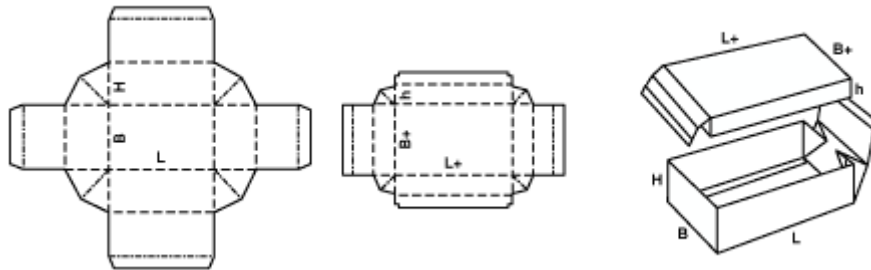

### Mudel nr 0325

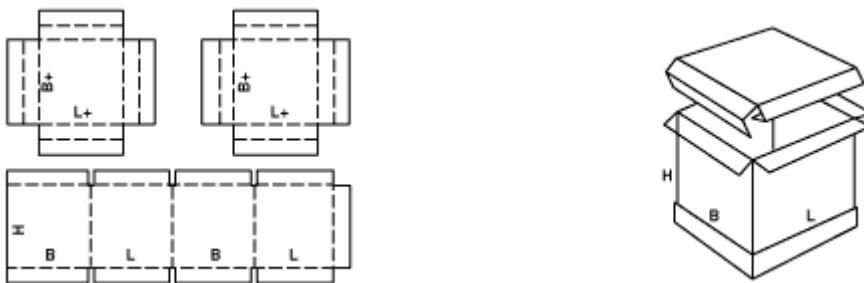

### Mudel nr 0330

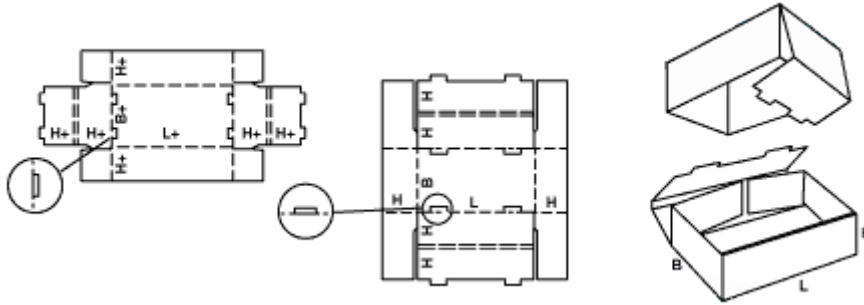

### Mudel nr 0331

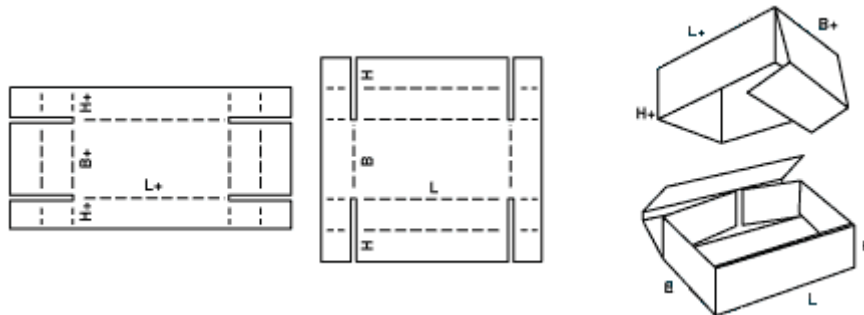

### Mudel nr 0350

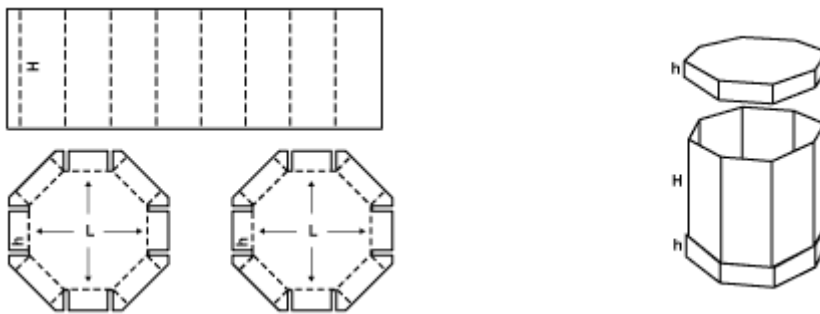



## Mudel nr 0351

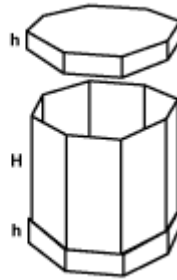
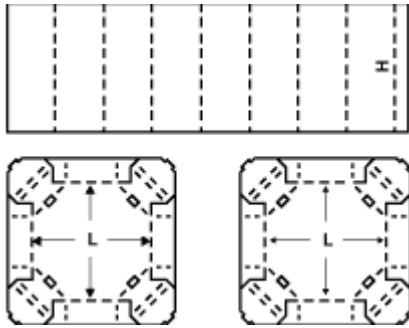

## Mudel nr 0352

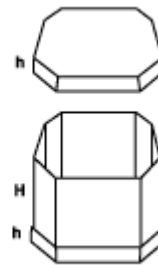
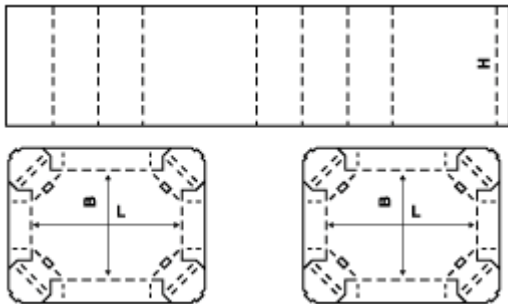

## FEFCO4

### Mudel nr 0400

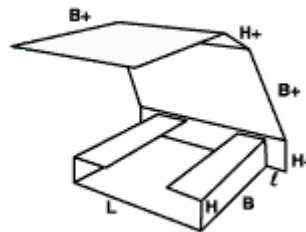
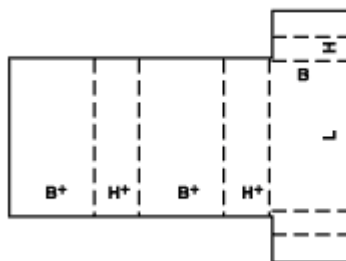

### Mudel nr 0401

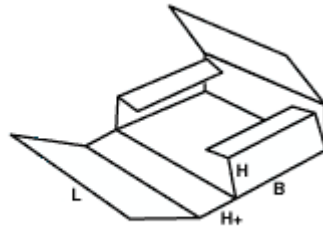
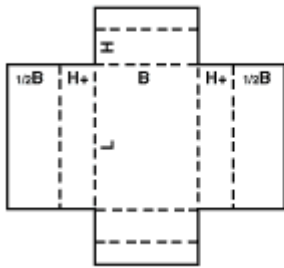

### Mudel nr 0402

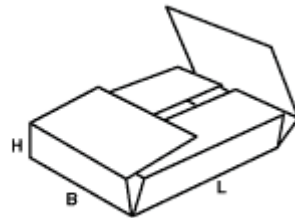

### Mudel nr 0403

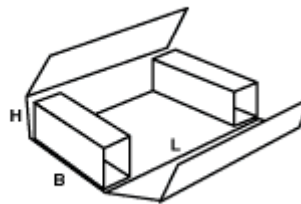
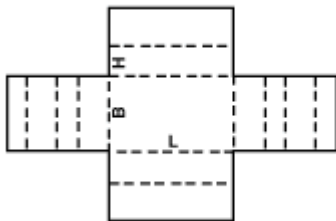

## Mudel nr 0404

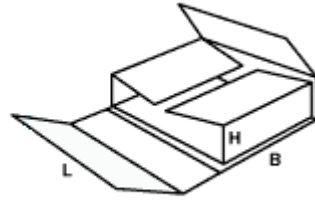
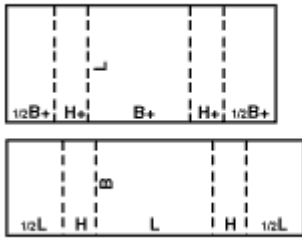

## Mudel nr 0405

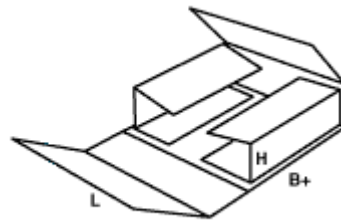
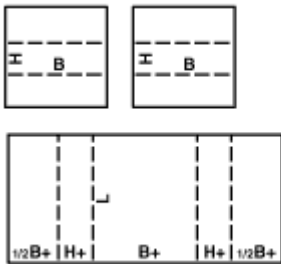

## Mudel nr 0406

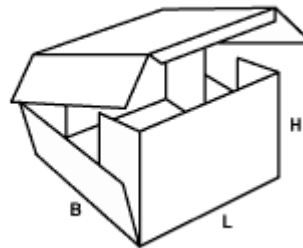
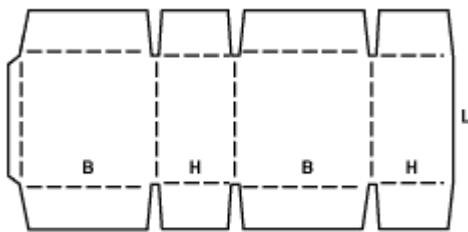

### Mudel nr 0409

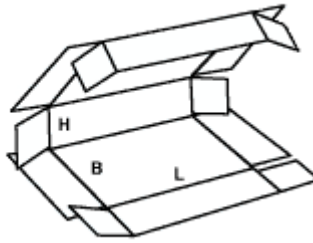
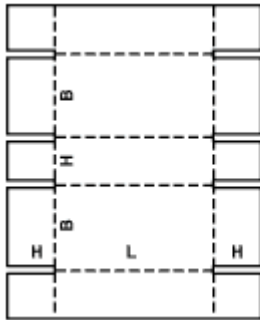

### Mudel nr 0410

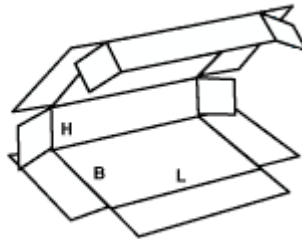

### Mudel nr 0411

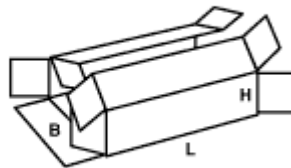

### Mudel nr 0412

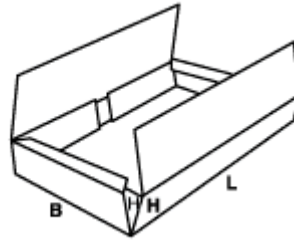
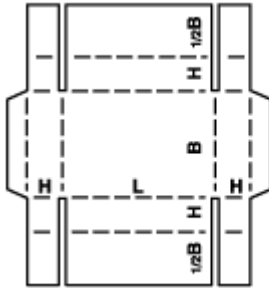

### Mudel nr 0413

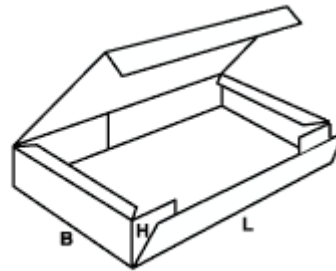
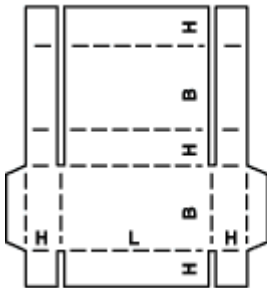

### Mudel nr 0415

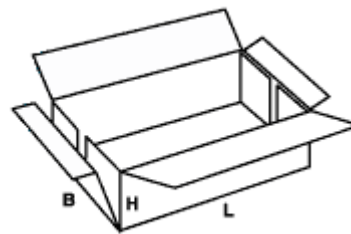
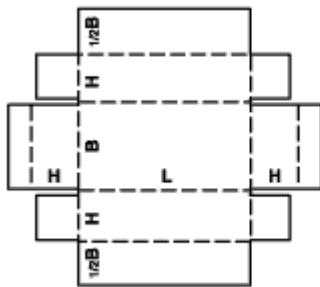

### Mudel nr 0416

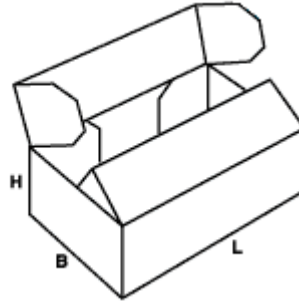
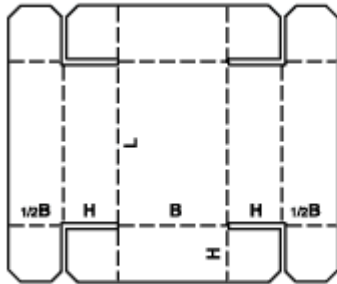

### Mudel nr 0420

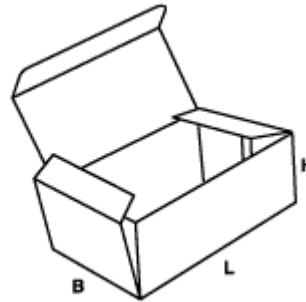
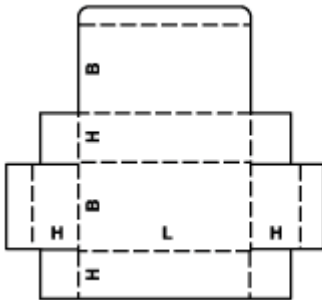

### Mudel nr 0421

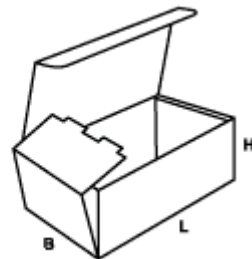
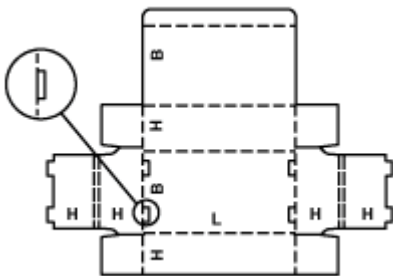

### Mudel nr 0422

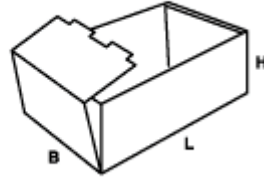
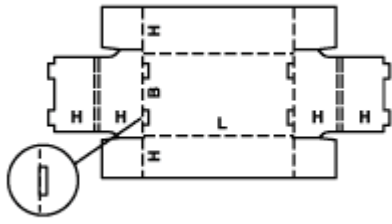

### Mudel nr 0423

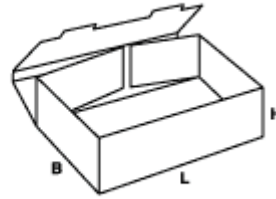
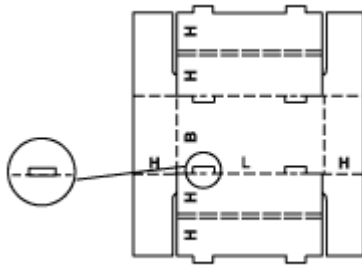

### Mudel nr 0424

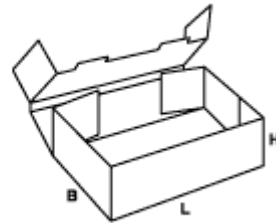
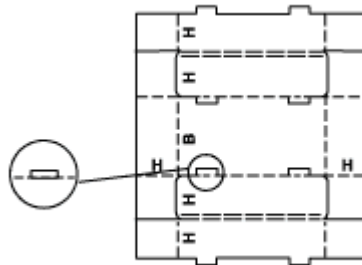

### Mudel nr 0425

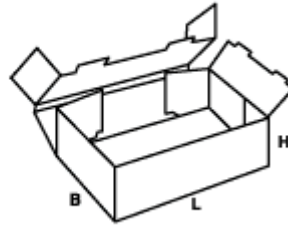
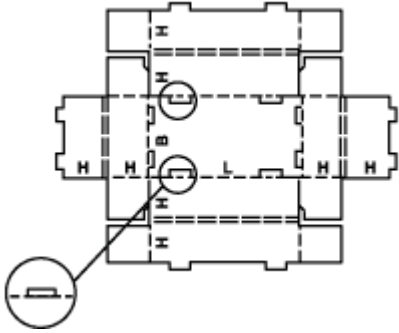

### Mudel nr 0426

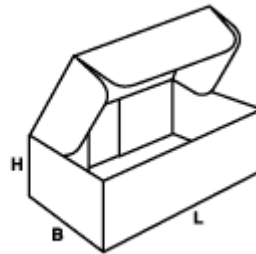
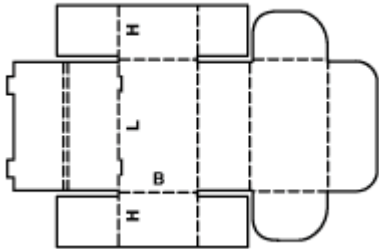

### Mudel nr 0427

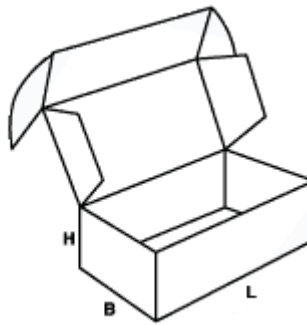
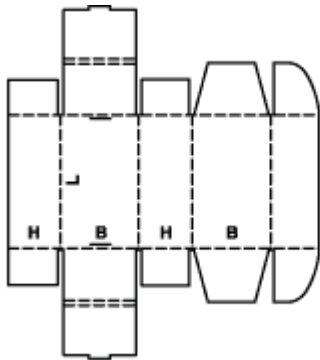



### Mudel nr 0428

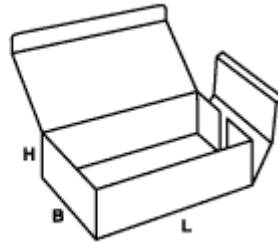
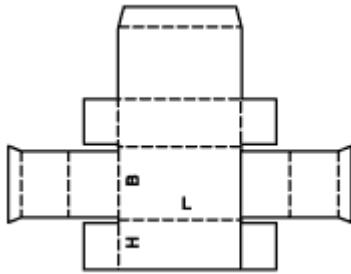

### Mudel nr 0429

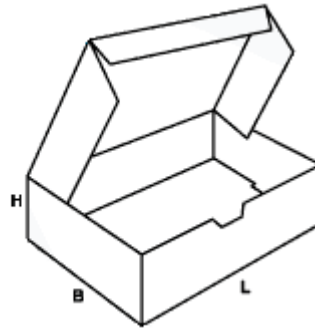
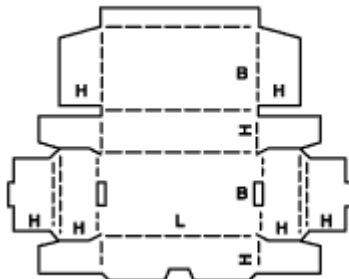

### Mudel nr 0430

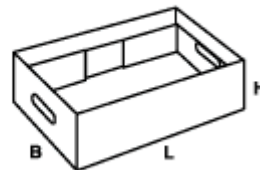
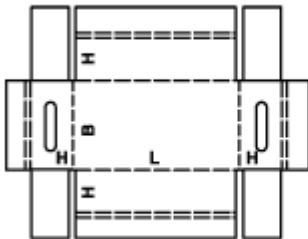

### Mudel nr 0431

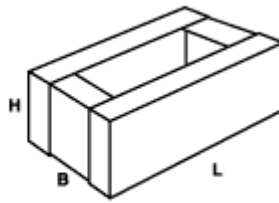
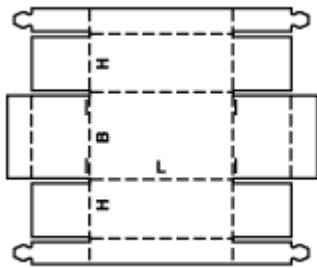

### Mudel nr 0432

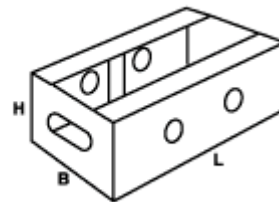
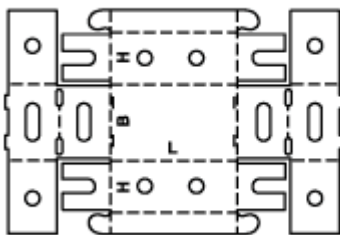

### Mudel nr 0433

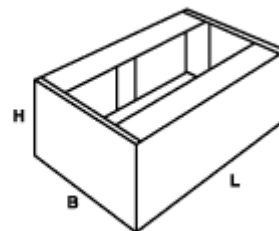
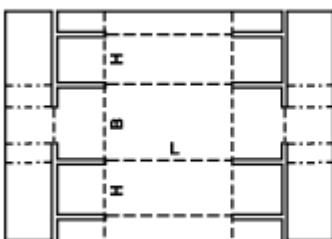

### Mudel nr 0434

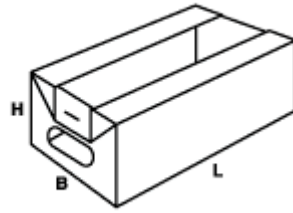
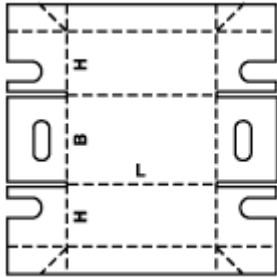

### Mudel nr 0435

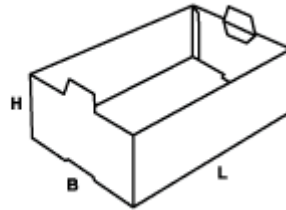
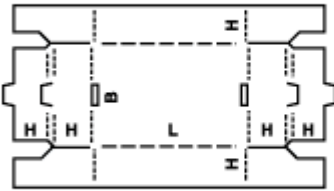

### Mudel nr 0436

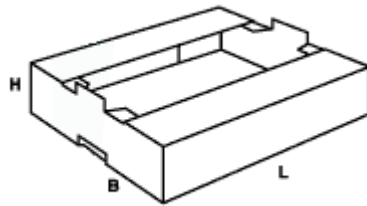
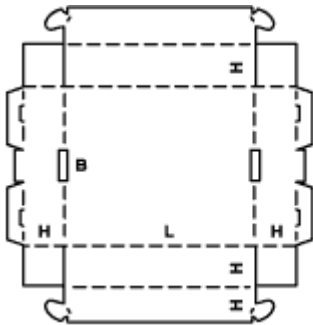

### Mudel nr 0437

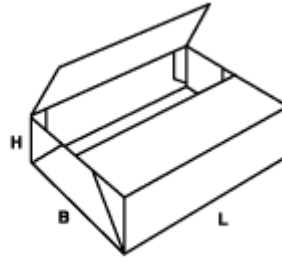
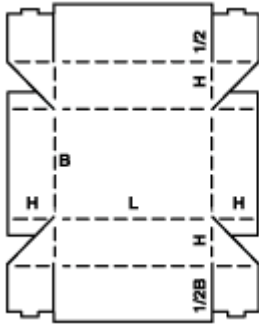

### Mudel nr 0440

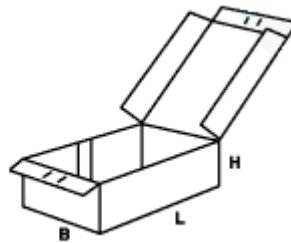
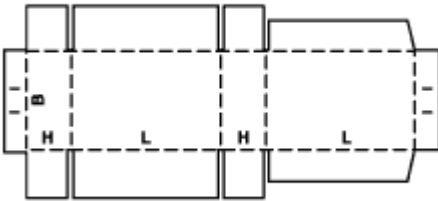

### Mudel nr 0441

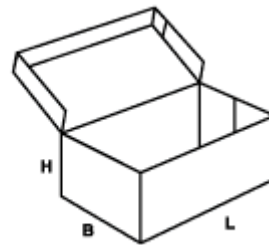
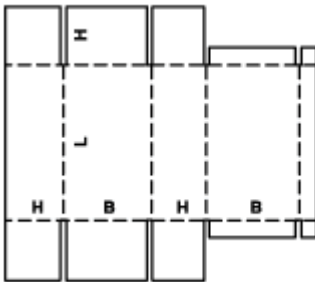

### Mudel nr 0442

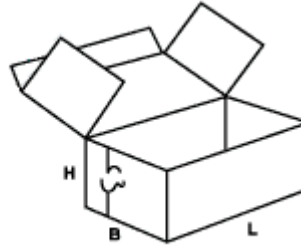
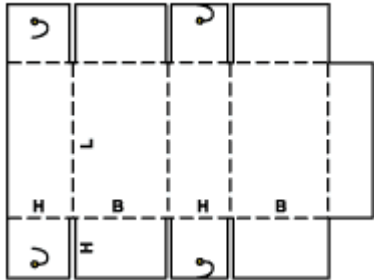

### Mudel nr 0443

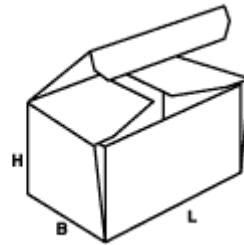
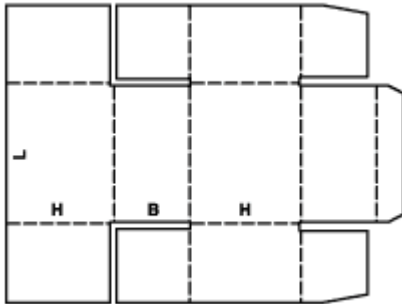

### Mudel nr 0444

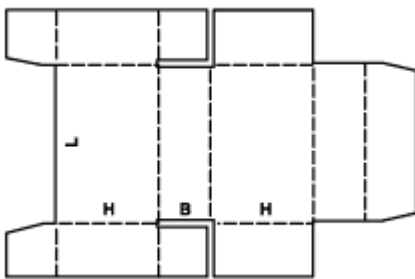

### Mudel nr 0445

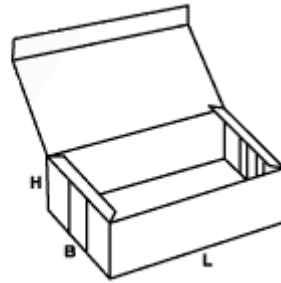
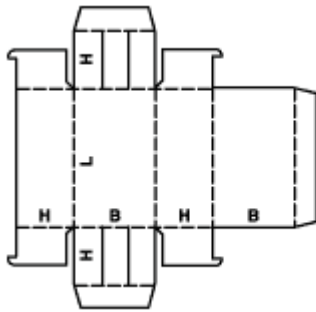

### Mudel nr 0446

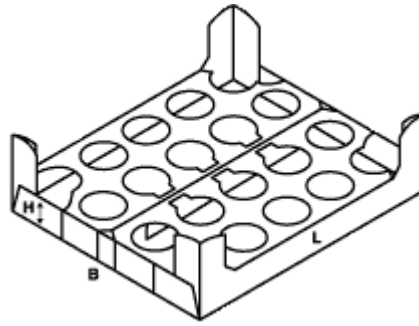
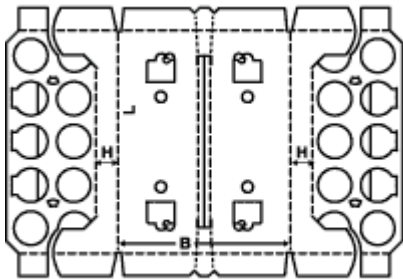

### Mudel nr 0447

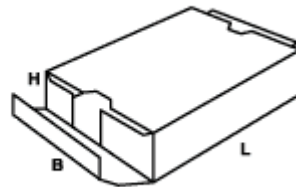
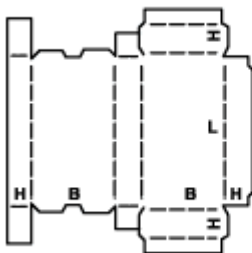

### Mudel nr 0448

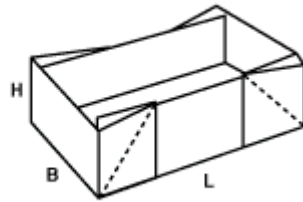
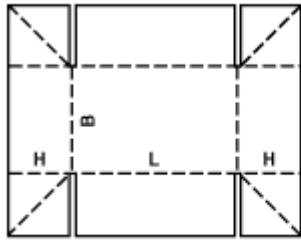

### Mudel nr 0449

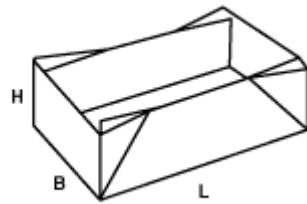
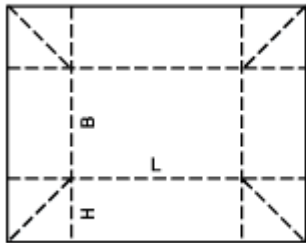

### Mudel nr 0450

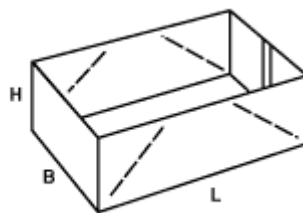
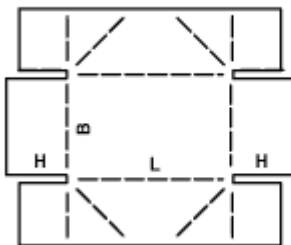

### Mudel nr 0451

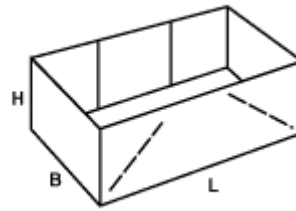
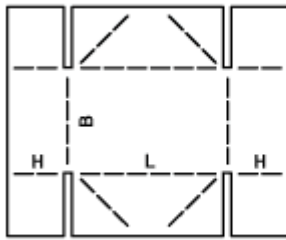

### Mudel nr 0452

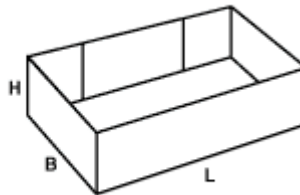
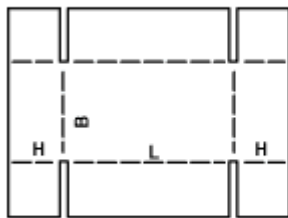

### Mudel nr 0453

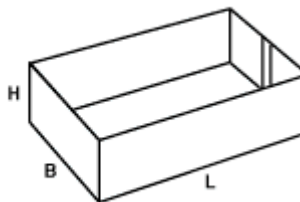
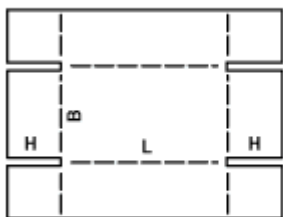



### Mudel nr 0454

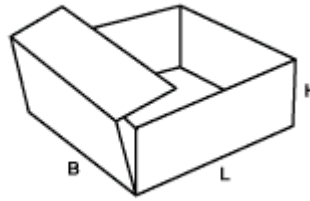
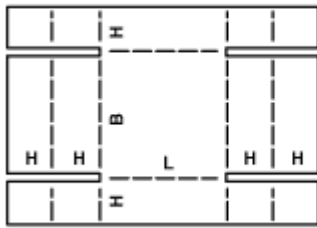

### Mudel nr 0455

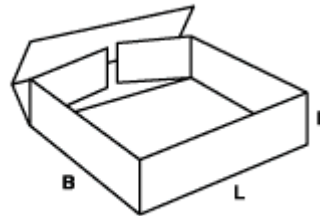
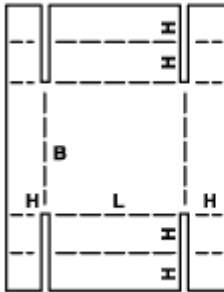

### Mudel nr 0456

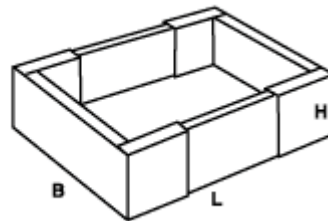
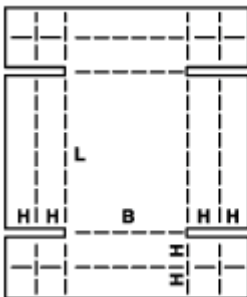

**Mudel nr 0457**

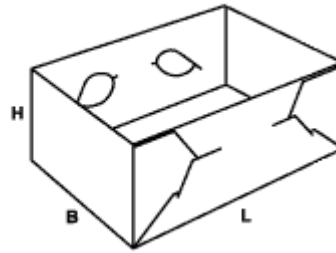
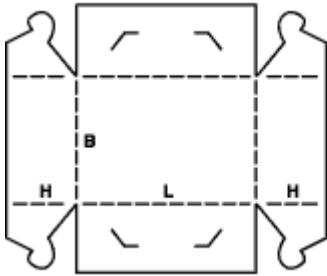

**Mudel nr 0458**

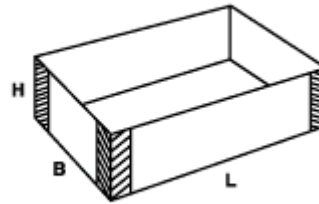
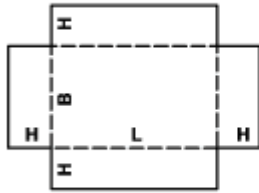

**Mudel nr 0459**

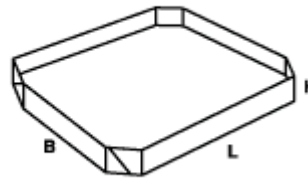
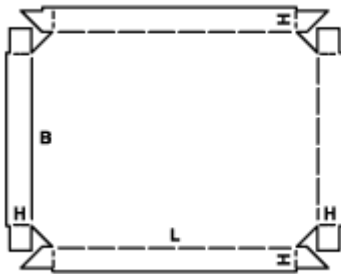

### Mudel nr 0460

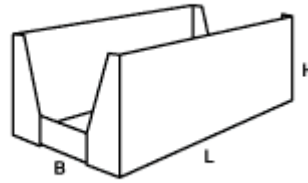
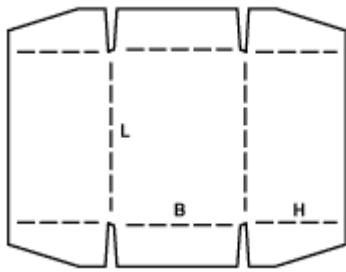

### Mudel nr 0470

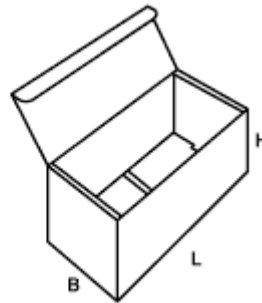
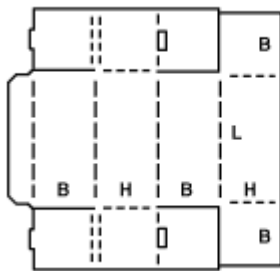

### Mudel nr 0471

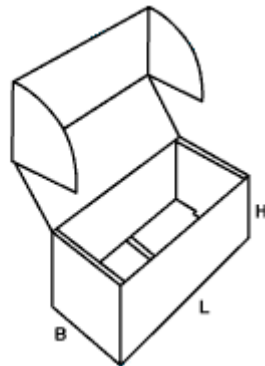
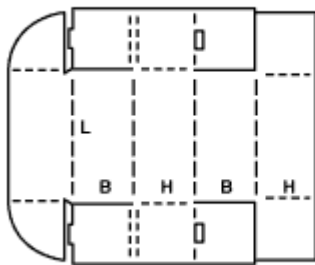

## Mudel nr 0472

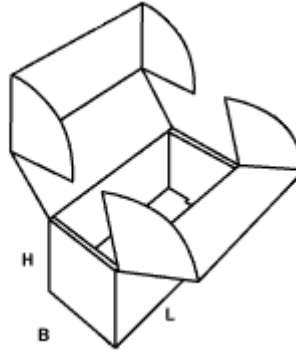
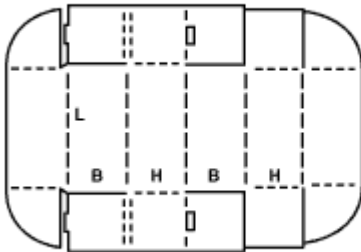

## Mudel nr 0473

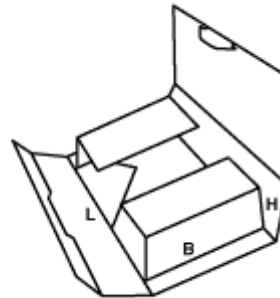
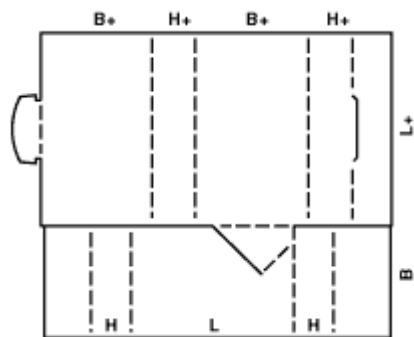

## FEFCO5

### Mudel nr 0501

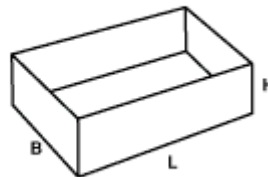
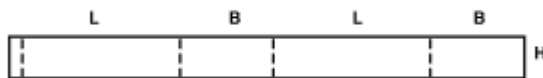

## Mudel nr 0502

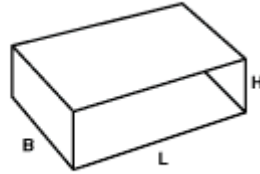
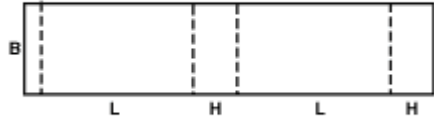

## Mudel nr 0503

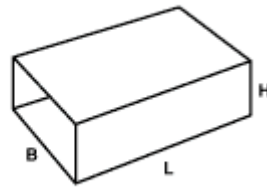
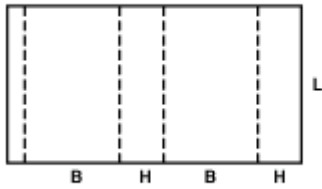

## Mudel nr 0504

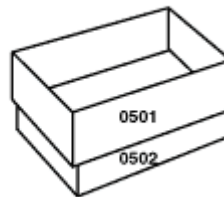

## Mudel nr 0505

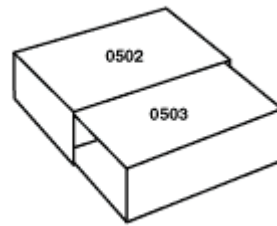

## Mudel nr 0507

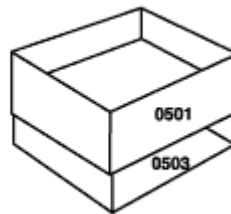

## Mudel nr 0508

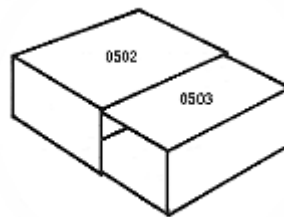

## Mudel nr 0509

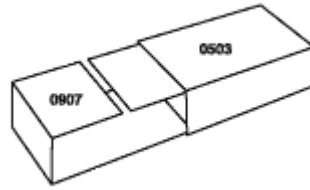

## Mudel nr 0510

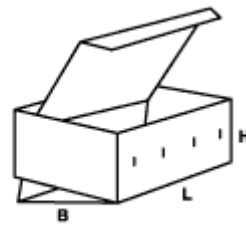
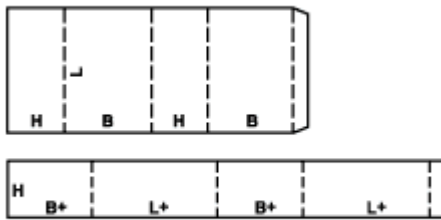

## Mudel nr 0511

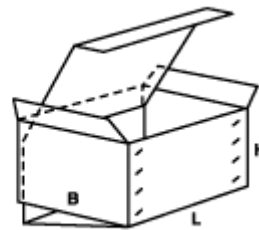
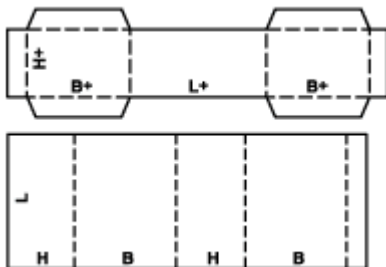

## Mudel nr 0512

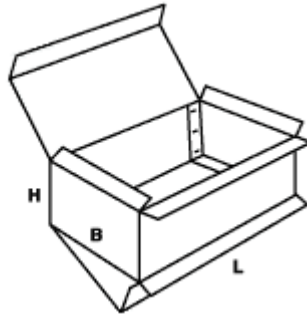
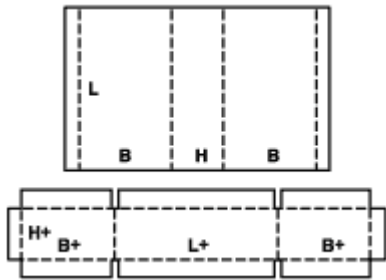

## FEFCO6

### Mudel nr 0601

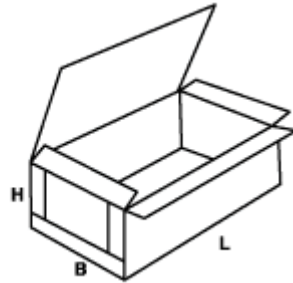
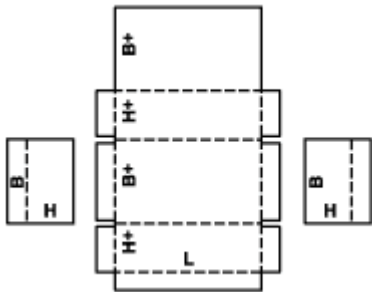

### Mudel nr 0602

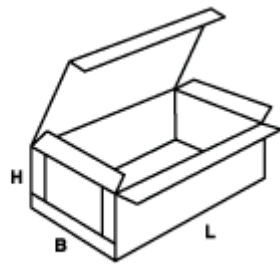
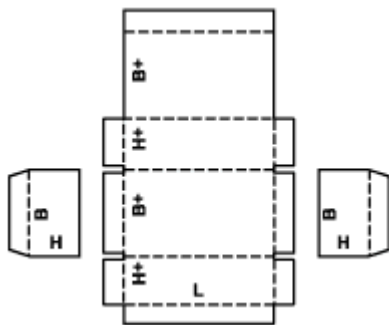



### Mudel nr 0605

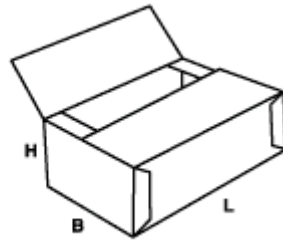
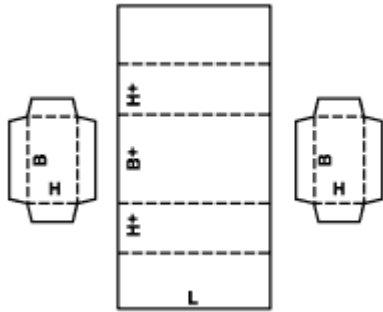

### Mudel nr 0606

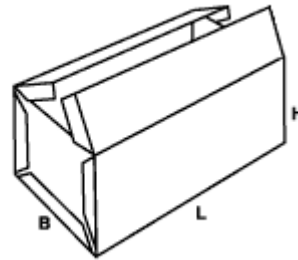
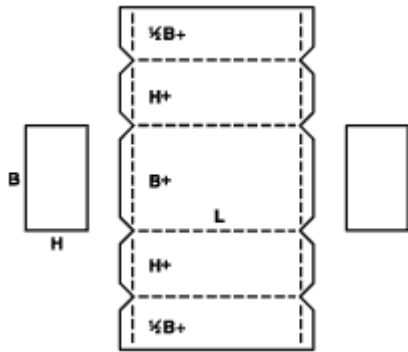

### Mudel nr 0607

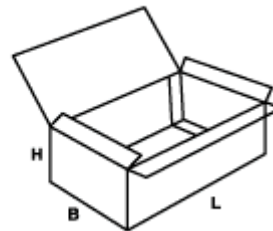
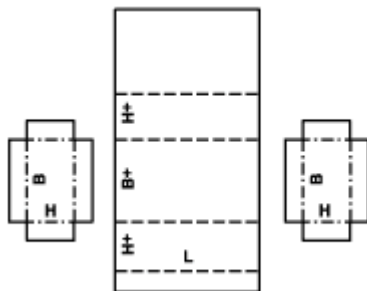

## Mudel nr 0608

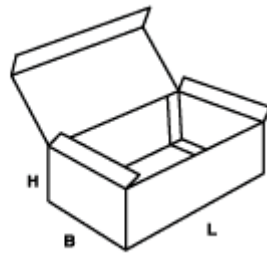
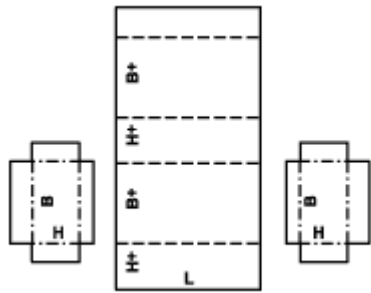

## Mudel nr 0610

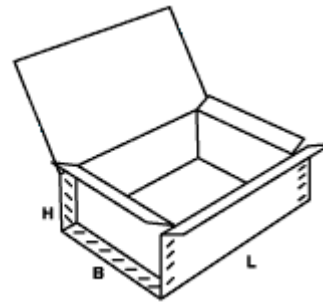
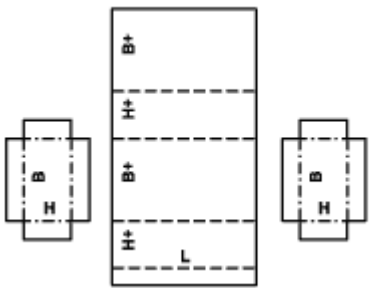

## Mudel nr 0615

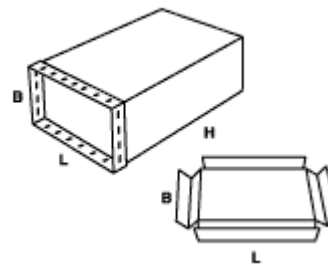
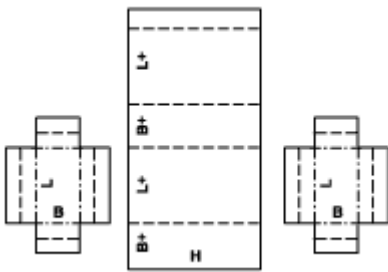

## Mudel nr 0616

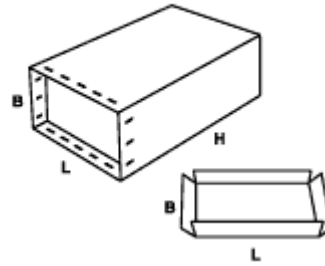
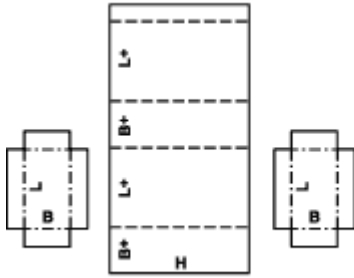

## Mudel nr 0620

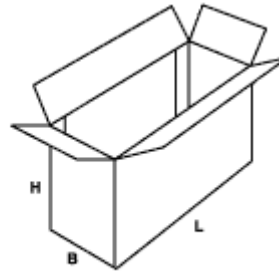
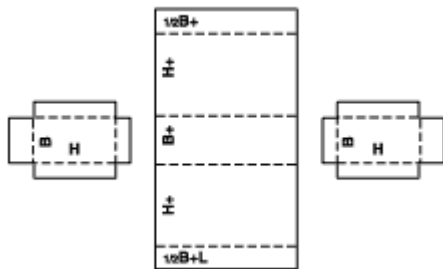

## Mudel nr 0621

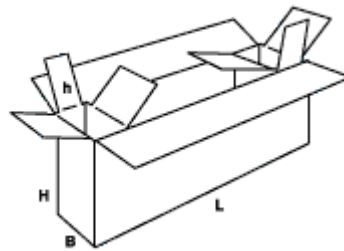
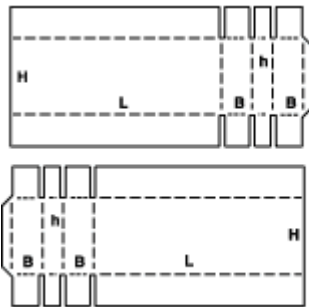

# FEFCO7

## Mudel nr 0700

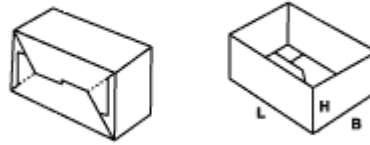
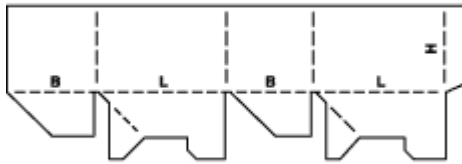

## Mudel nr 0701

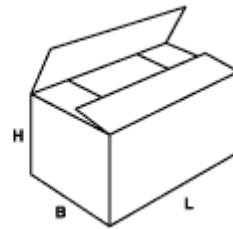
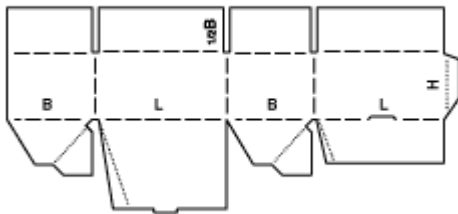

## Mudel nr 0703

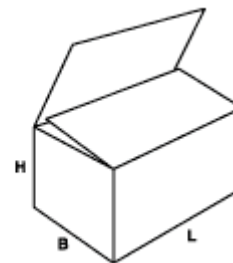
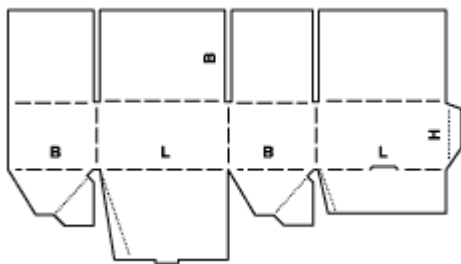

## Mudel nr 0711

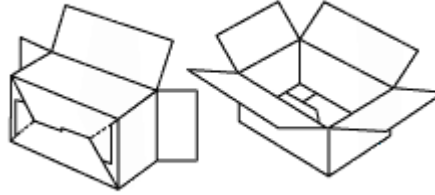
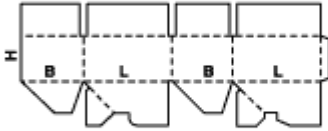

## Mudel nr 0712

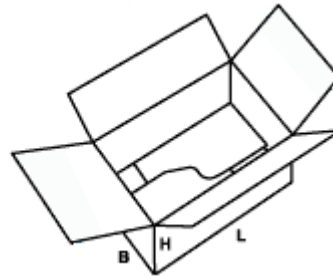
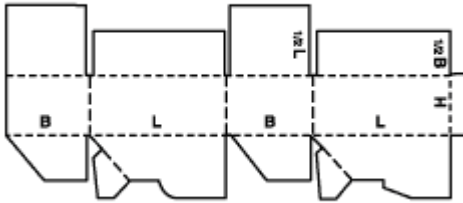

## Mudel nr 0713

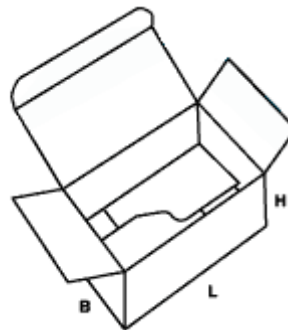
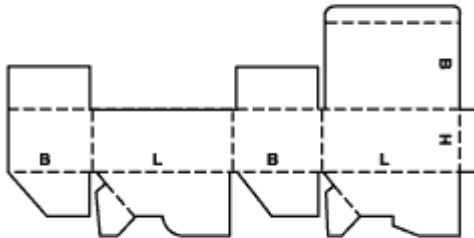

## Mudel nr 0714

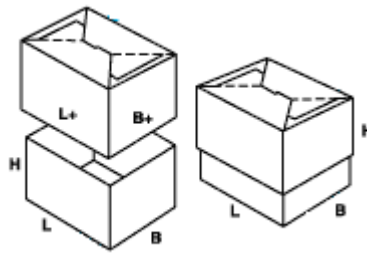
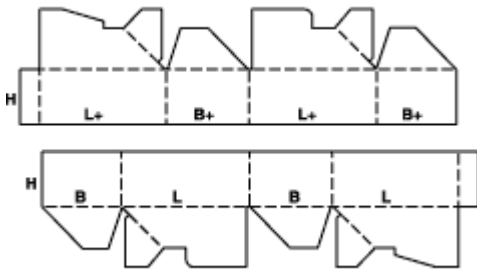

## Mudel nr 0715

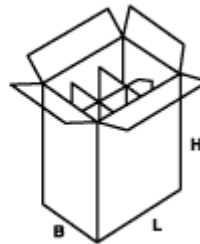
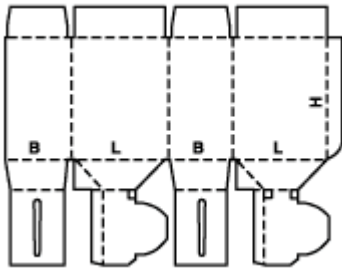

## Mudel nr 0716

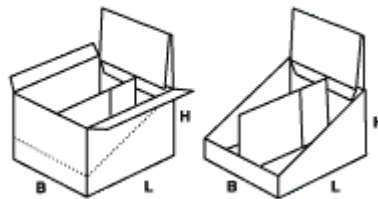
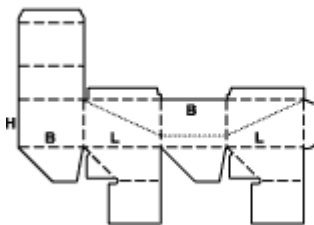

**Mudel nr 0717**

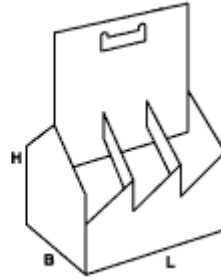
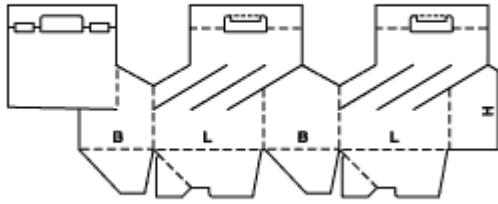

**Mudel nr 0718**

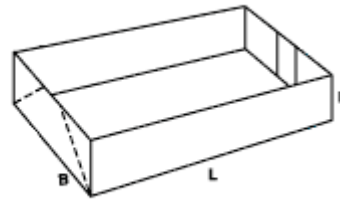
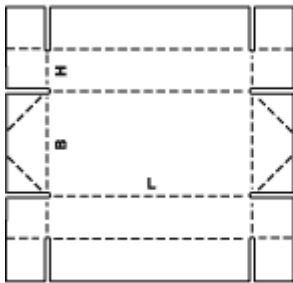

**Mudel nr 0747**

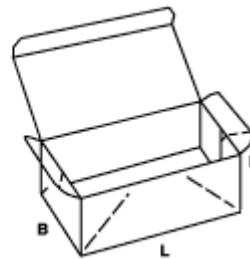
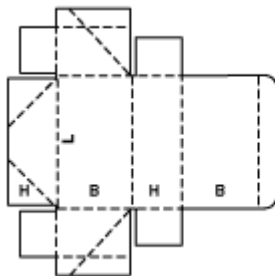

### Mudel nr 0748

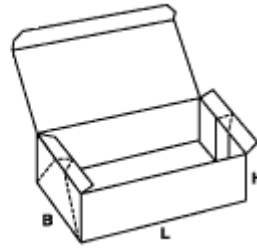
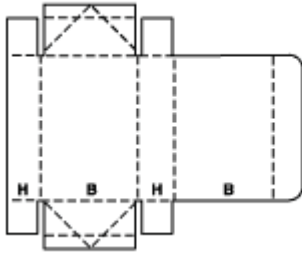

### Mudel nr 0751

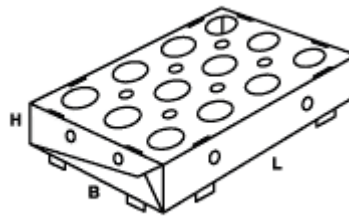
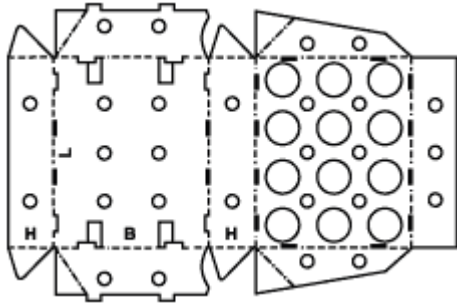

### Mudel nr 0752

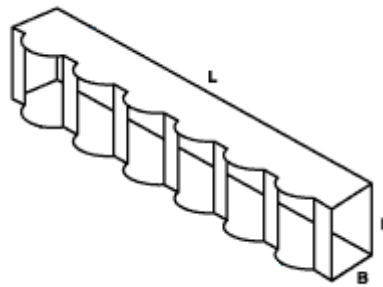
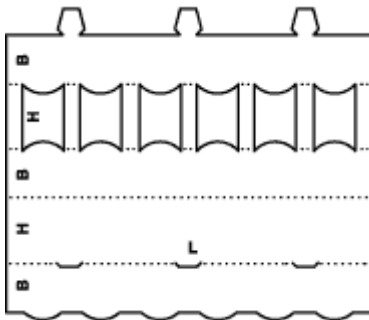



## Mudel nr 0759

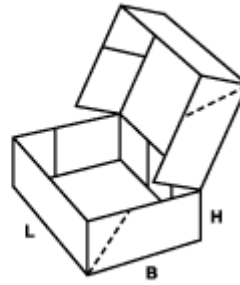
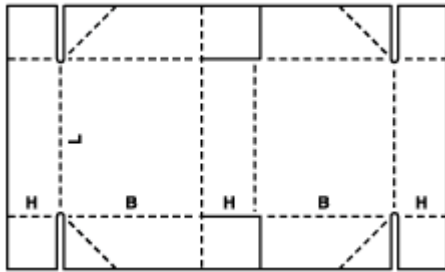

## Mudel nr 0760

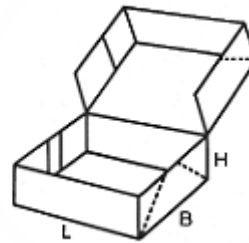
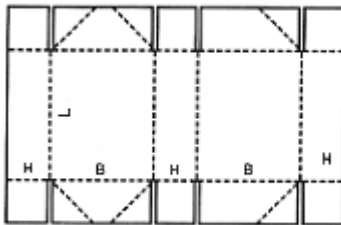

## Mudel nr 0761

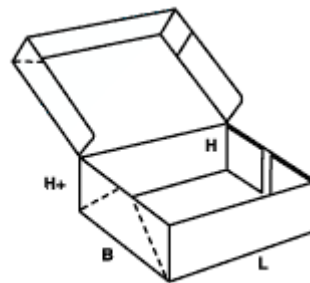
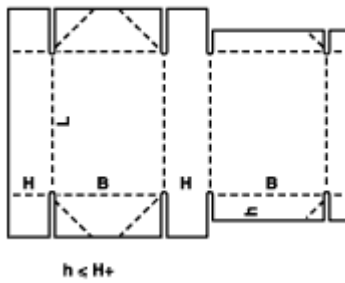

### Mudel nr 0770

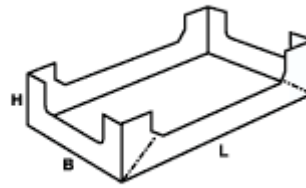
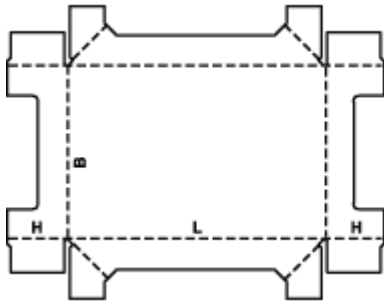

### Mudel nr 0771

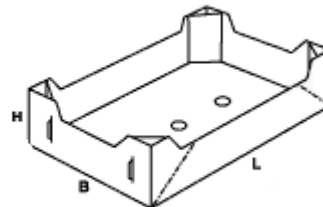
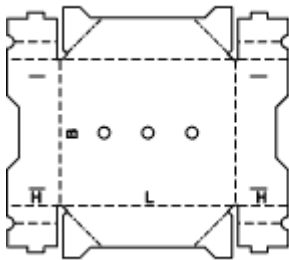

### Mudel nr 0772

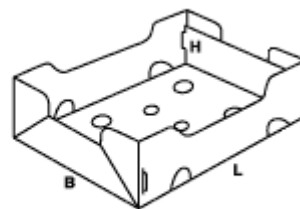
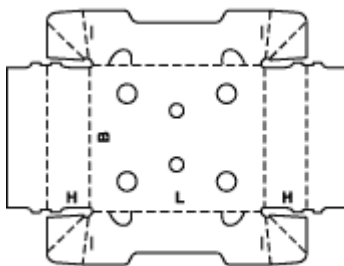

## Mudel nr 0773

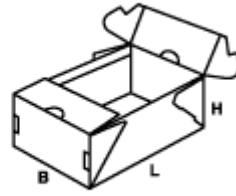
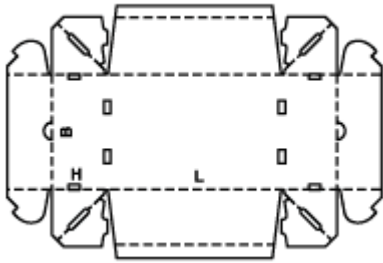

## Mudel nr 0774

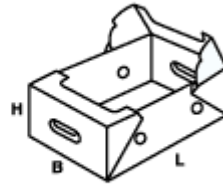
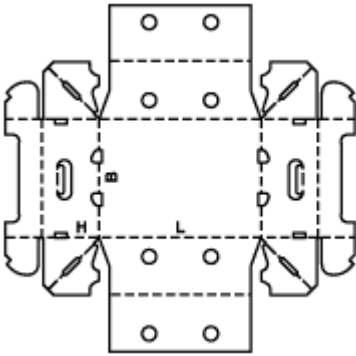

# FEFCO9

**Mudel nr 0900**

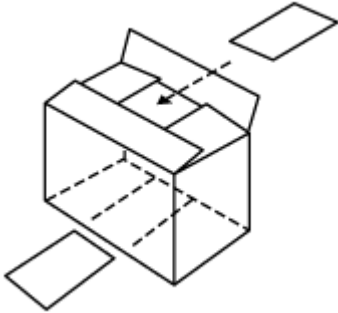

**Mudel nr 0901**

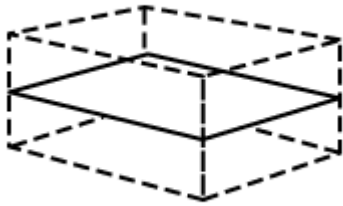

**Mudel nr 0902**

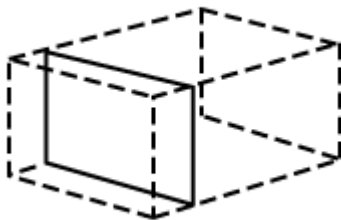

**Mudel nr 0903**

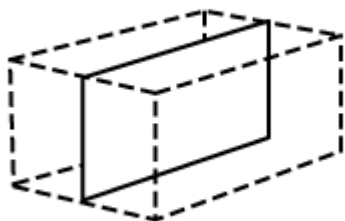

**Mudel nr 0904**

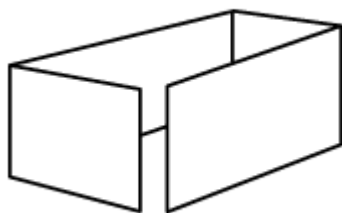

**Mudel nr 0905**

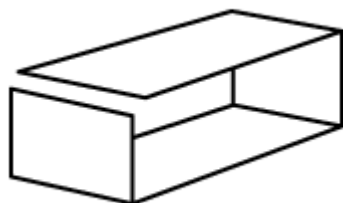

**Mudel nr 0906**

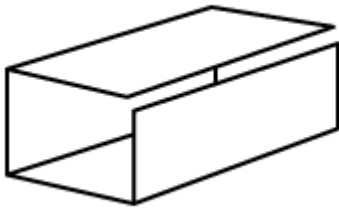

**Mudel nr 0907**

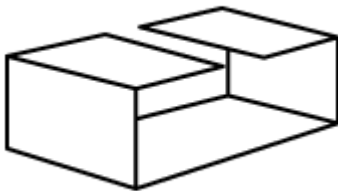

**Mudel nr 0908**

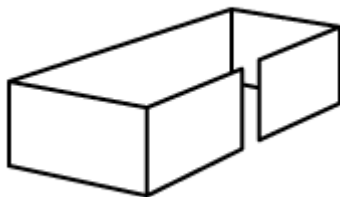

**Mudel nr 0909**

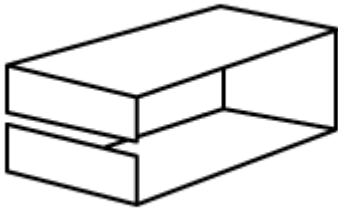

**Mudel nr 0910**

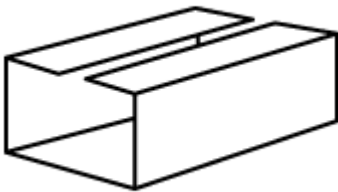

**Mudel nr 0911**

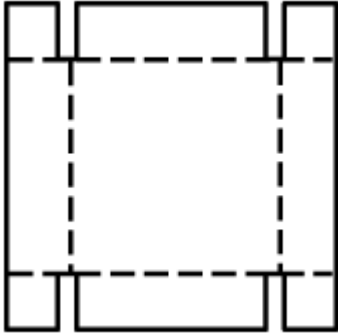

**Mudel nr 0913**

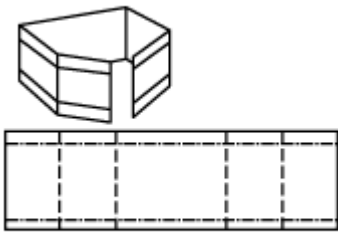



**Mudel nr 0914**

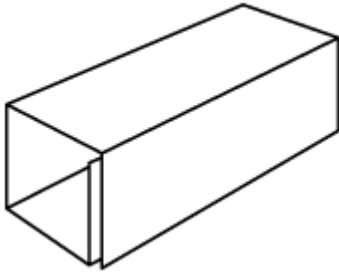

**Mudel nr 0920**

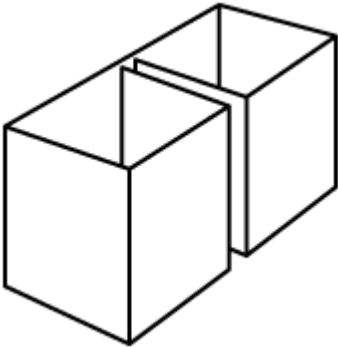

**Mudel nr 0921**

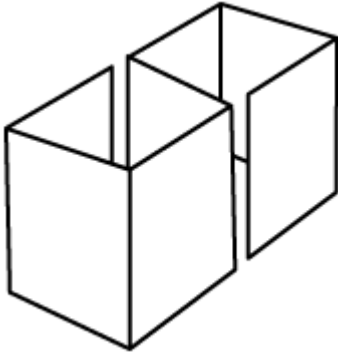

**Mudel nr 0929**

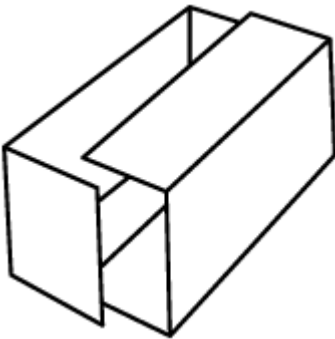

**Mudel nr 0930**

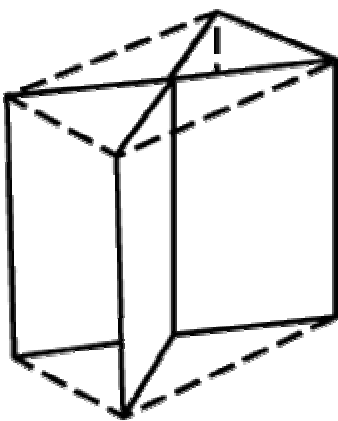

**Mudel nr 0931**

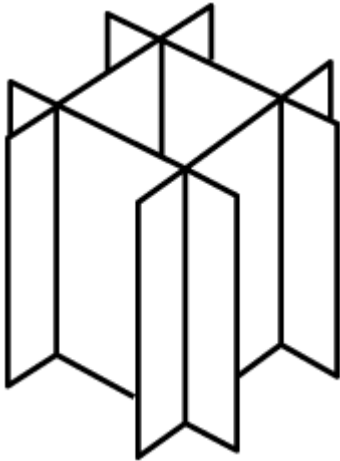

**Mudel nr 0932**

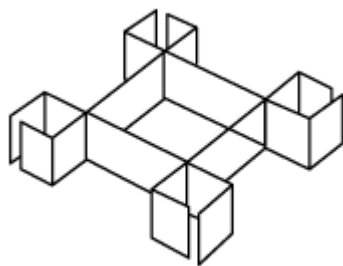

**Mudel nr 0933**

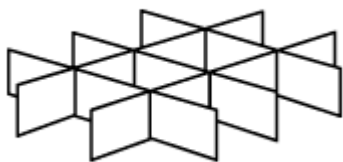

**Mudel nr 0934**

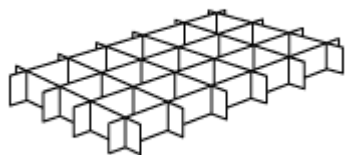

**Mudel nr 0935**

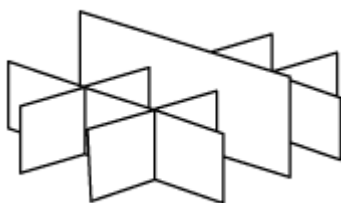

**Mudel nr 0940**



**Mudel nr 0941**

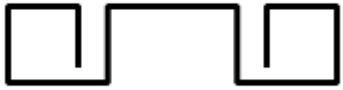

**Mudel nr 0942**



**Mudel nr 0943**



**Mudel nr 0944**



**Mudel nr 0945**



**Mudel nr 0946**

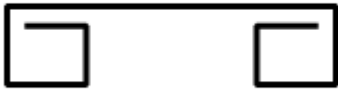

**Mudel nr 0947**

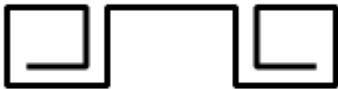

**Mudel nr 0948**

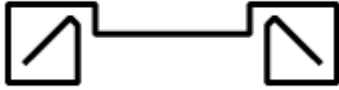

**Mudel nr 0949**



**Mudel nr 0950**



**Mudel nr 0951**



**Mudel nr 0965**

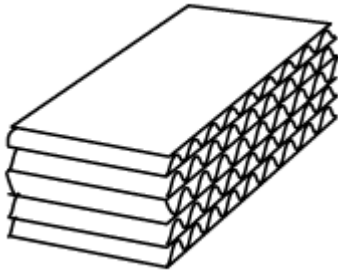

**Mudel nr 0966**

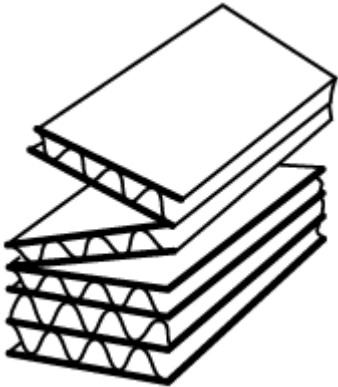



**Mudel nr 0967**

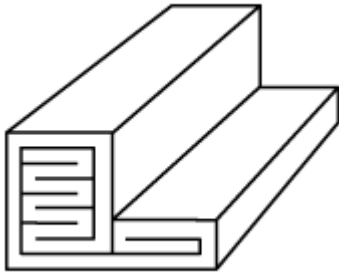

**Mudel nr 0970**



**Mudel nr 0971**



**Mudel nr 0972**



**Mudel nr 0973**



**Mudel nr 0974**



**Mudel nr 0975**



**Mudel nr 0976**

