

Dollar Squirrel

Designed by Janessa Munt

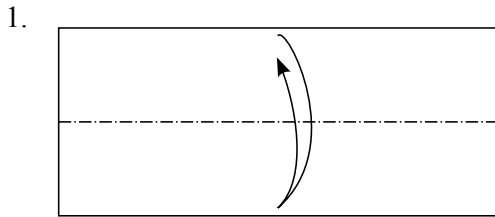

Fold and unfold

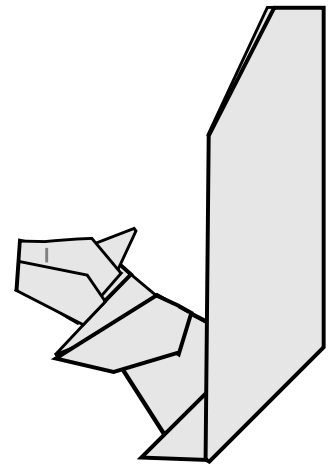
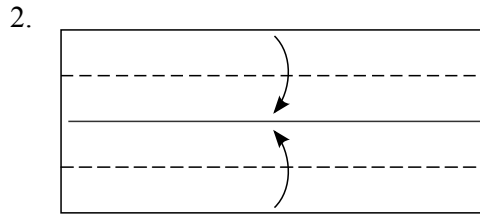

Fold edges to center

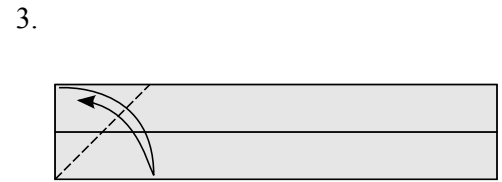

Fold and unfold

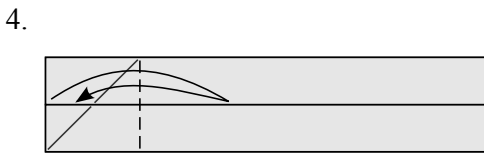

Fold and unfold

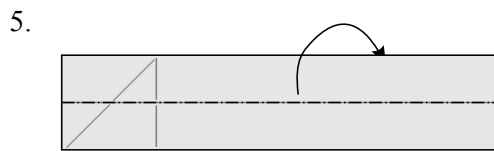

Fold top half behind

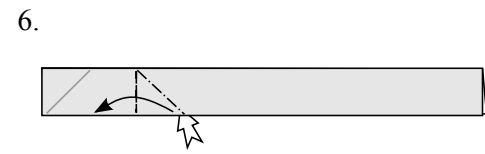

Squash

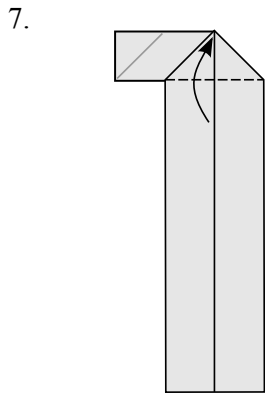

Fold upwards
Next steps are magnified

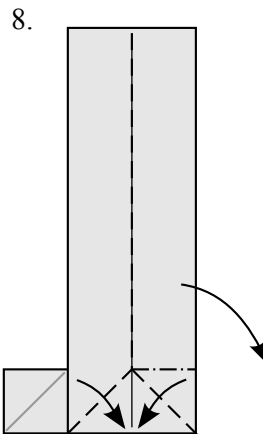

Rabbit ear



Fold and unfold

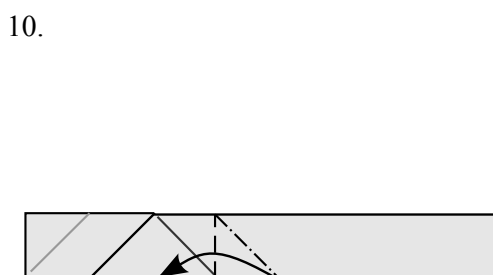

Repeat steps 6-8

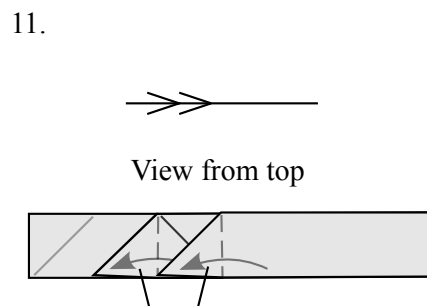

On the back side, fold these flaps
so they all face the same direction

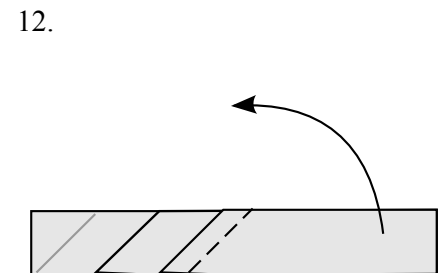

Outside reverse fold
Next steps are magnified

13.

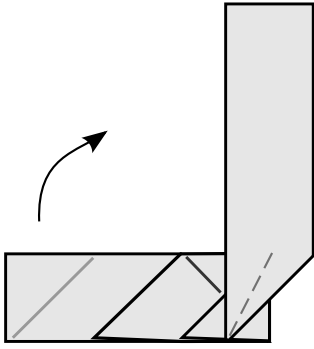

Swivel upwards

14.

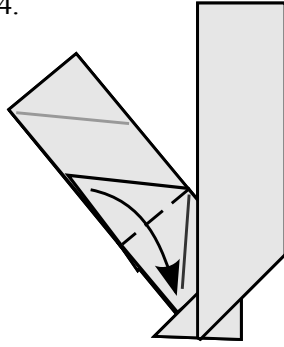

Valley fold

15.

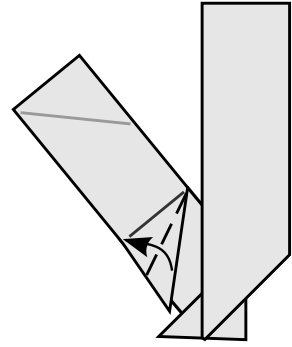

Valley fold

16.

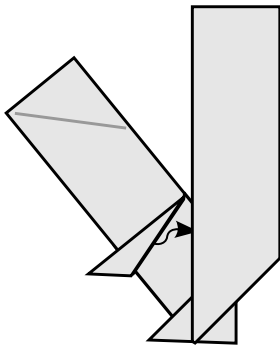

Pull out layer

17.

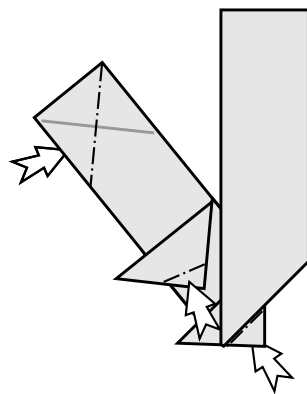

Inside reverse folds

18.

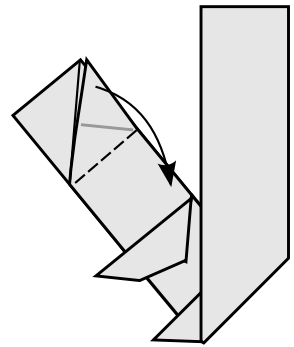

Valley fold

19.

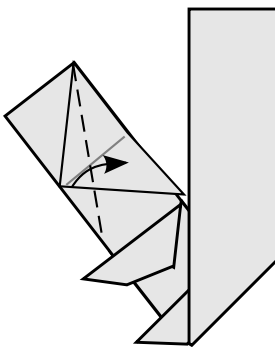

Valley fold

20.

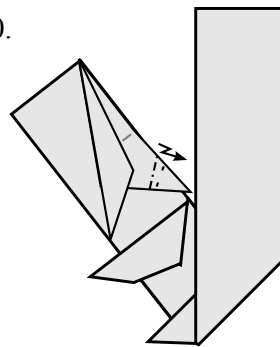

Pleat

21.

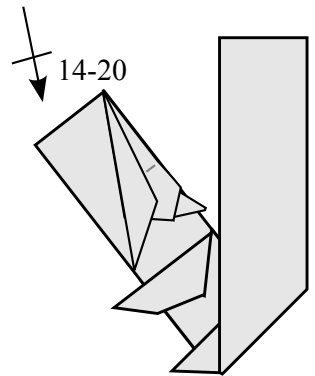

Repeat steps 14-20 on back

22.

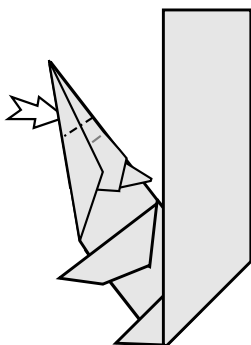

Inside reverse fold

23.

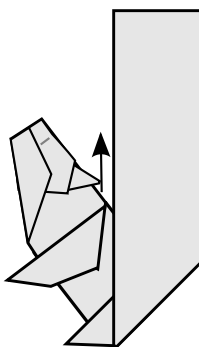

Swivel up

24.

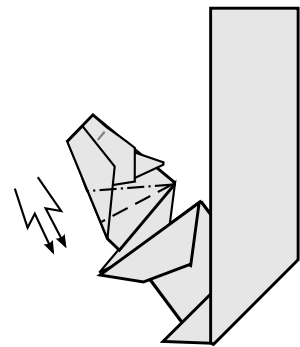

Crimp, repeat on back

25.

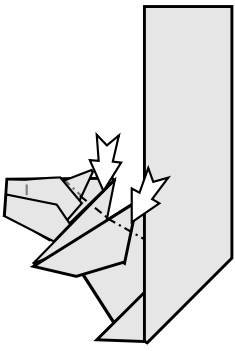

Closed sink

26.

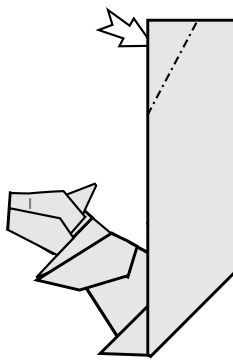

Inside reverse fold top layer only

27.

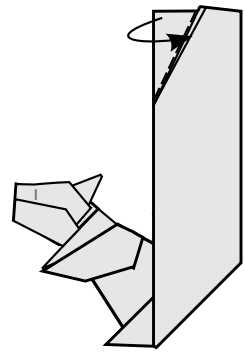

Tuck in

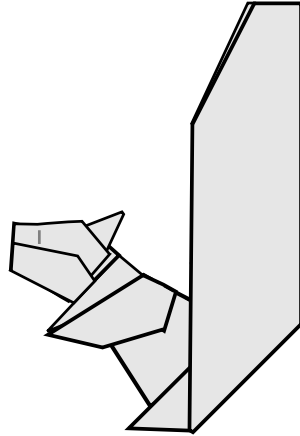

Completed squirrel!