

This drawing is property of Pevco Systems International, Inc. It may not be copied or exhibited without written permission.

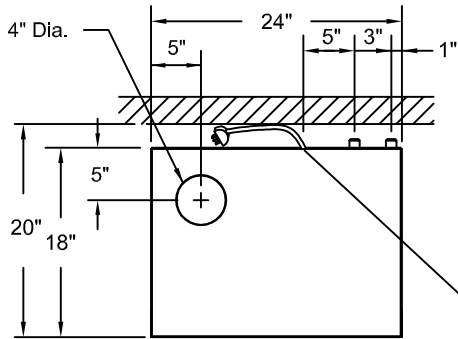

PLAN VIEW

NOTES:

1. STATION REQUIRES 120 VOLT, 5 AMP DEDICATED CIRCUIT (PROVIDED BY OTHERS).
2. TWO 7/8" DIA HOLES IN THE BACK OF STATION FOR COMMUNICATION CABLE CONNECTION.
3. STATION TO BE FLOOR MOUNTED.
4. RECOMMENDED CONTROL PANEL HEIGHT IS 5'-0".
5. STATION WEIGHT IS 211 LBS.

SERVICE DISCONNECT FACTORY WIRED (INSIDE UNIT)

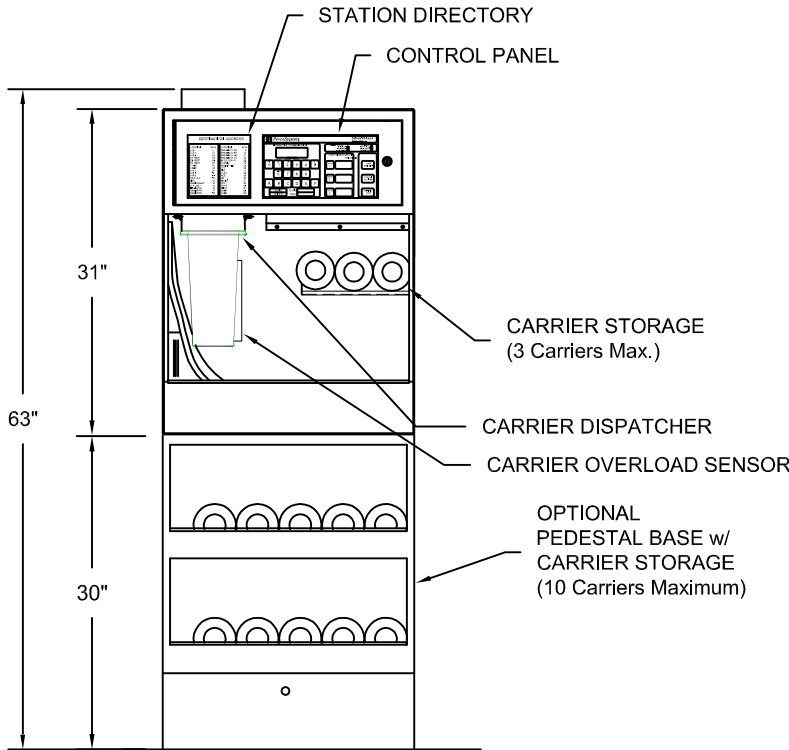

FRONT VIEW

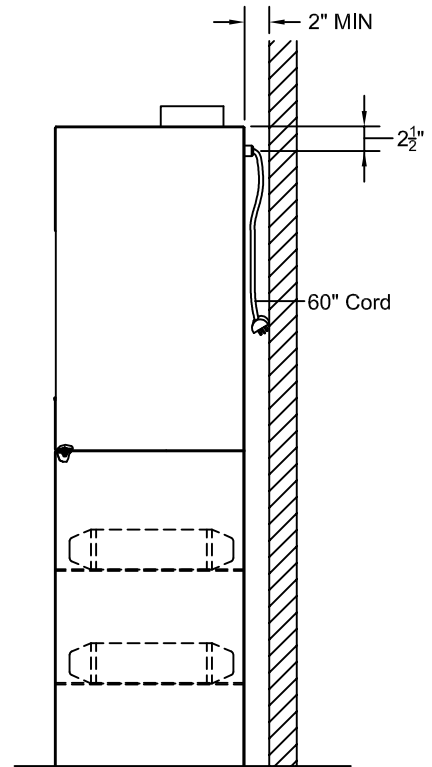

SIDE VIEW



1401 Tangier Drive
 Baltimore, Maryland 21220
 T 410.931.8800, F 410.931.4660
 800.296.PEVCO (7382), www.pevco.com

**COMPACT (1-PORT) STATION
 WITH OPTIONAL PEDESTAL**

4" COMPUTERIZED PNEUMATIC TUBE SYSTEMS

SCALE	NONE	DATE
DRAWN	BK/SDW	05.12.10
REVISED	SDW	12.03.10
	SDW	02.11.11
DRAWING NUMBER	PEV200.33	REVISION 2