

Side View - Retracted

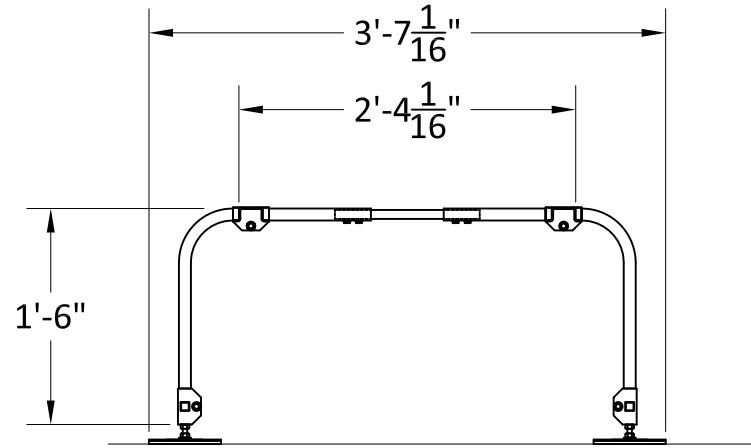

Side View - Expanded

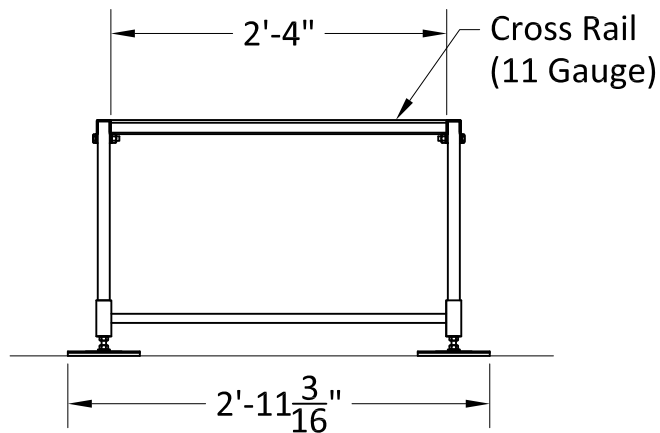

End View - Fixed

Alternate Carriage
Bolt Hole (typ)

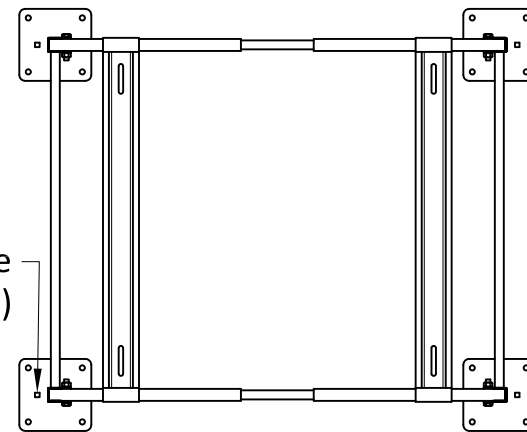

Plan View - Expanded



ASSEMBLY DRAWING
"MINI-SPLIT 18"
ADJUSTABLE STAND - WIDE
MODEL NO. QSMS1802

www.quick-sling.com
email: info@quick-sling.com
fax: 1-(800)-699-0423

Quick Sling, LLC
391 W. Water Street
Taunton, MA 02780
1-(800)-699-0543