

IAM

A PRINT TEST

AVANT D'IMPRIMER VOTRE PATRON, ASSUREZ VOUS QUE LES REGLAGES DE VOTRE IMPRIMANTE SOIENT EN TAILLE 100%.

BEFORE PRINTING YOUR PATTERN, MAKE SURE YOUR PRINTER'S SETTINGS ARE SET ON 100 %.

Si vous n'êtes pas sûre des réglages de votre imprimante, faites le test d'impression avec cette première page : un carré imprimé de 10X10 cm. Si le carré imprimé sort plus grand ou plus petit, il vous faut revoir les options d'impression. Quand vous avez imprimé votre carré avec les bonnes valeurs, vous pouvez imprimer le reste de votre patron.

If you are not sure, print this page only and verify that the square is 10 cm by 10 cm. If the printed square is smaller or larger, check your printer's scale options and make sure they are set at 100%. Once the square is at the right value, you can print the entire document.

UNE FOIS VOTRE PATRON IMPRIME, COLLEZ LES FEUILLES ENSEMBLE EN SUIVANT LE PLAN D'ASSEMBLAGE (PAGE SUIVANTE).

ONCE YOU HAVE PRINTED YOUR PATTERN, STICK THE PAGES TOGETHER AS SHOWN ON THE ASSEMBLY PLAN (NEXT PAGE).

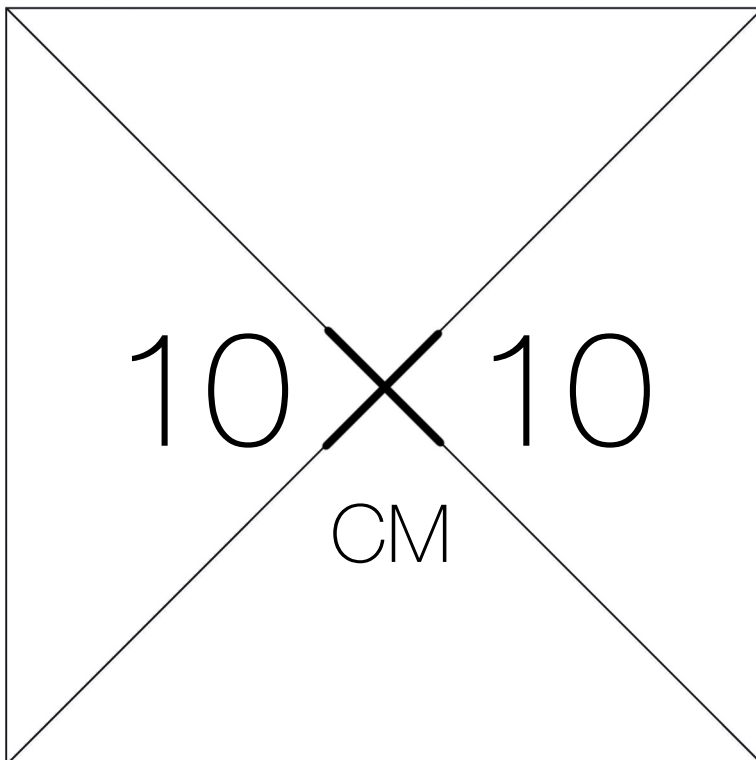

IAM

DEBARDEUR

MON COURS DE MACHINE A COUDRE

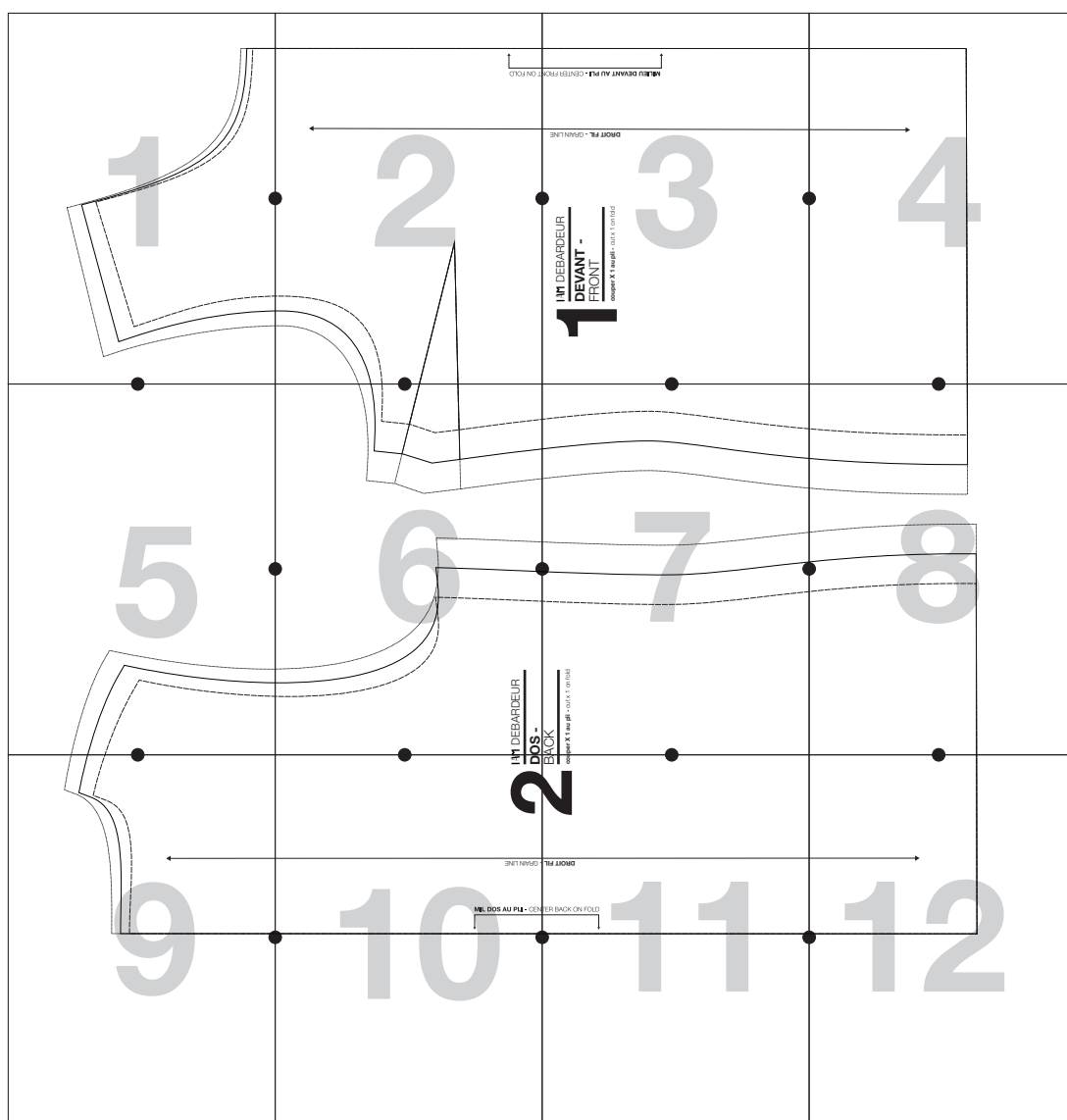

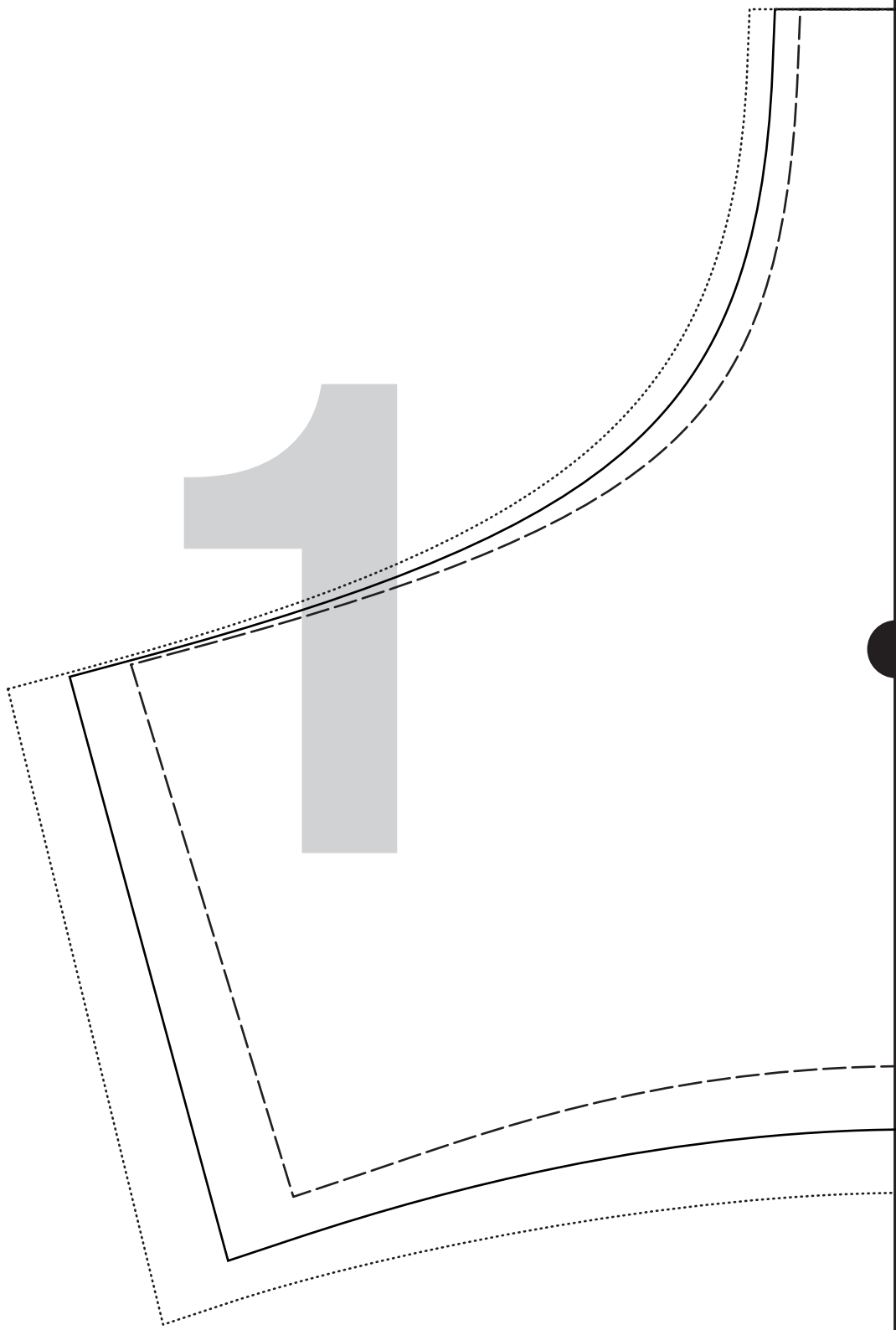

↑
T ON FOLD

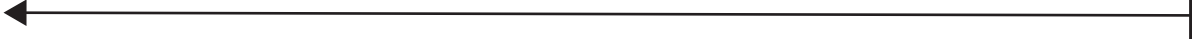

2

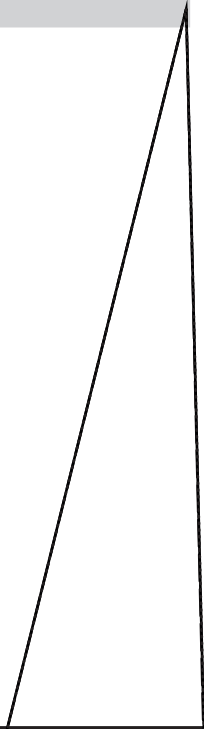
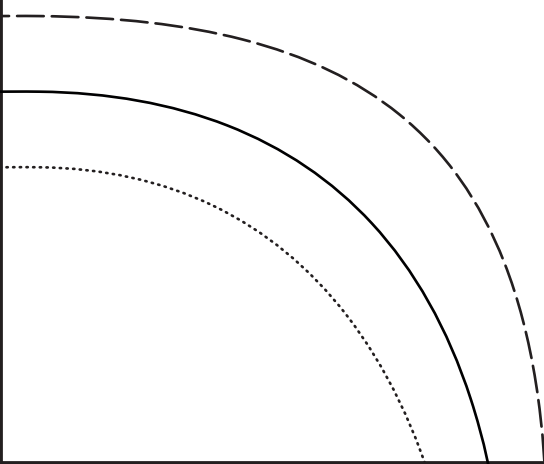

1

IAM DEBARDEUR

DEVANT -
FRONT

couper X 1 au pli - cut x 1 on fold

3

DROIT FIL - GRAIN LINE

MILIEU DEVANT AU PLI - CENTER FRONT





4

5

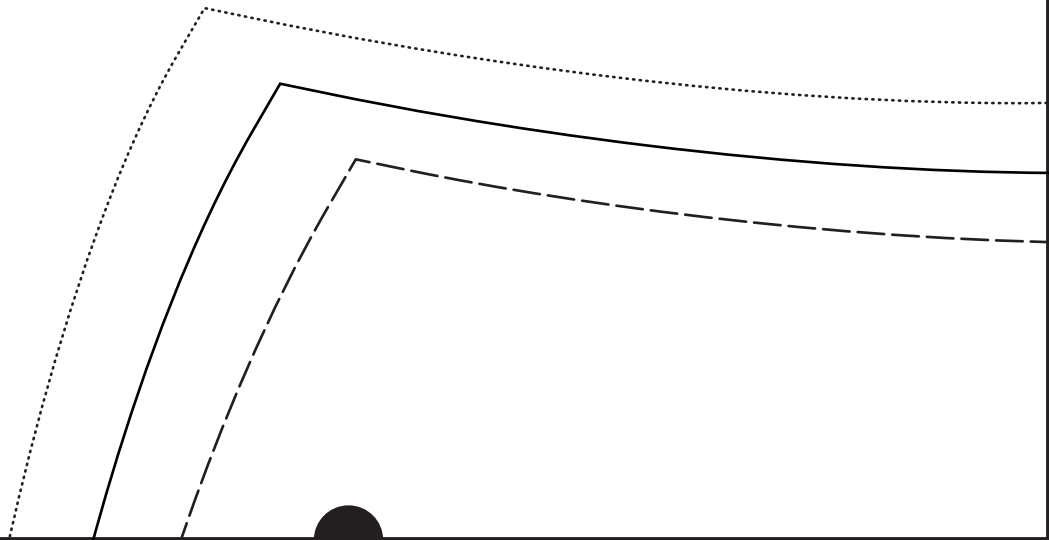

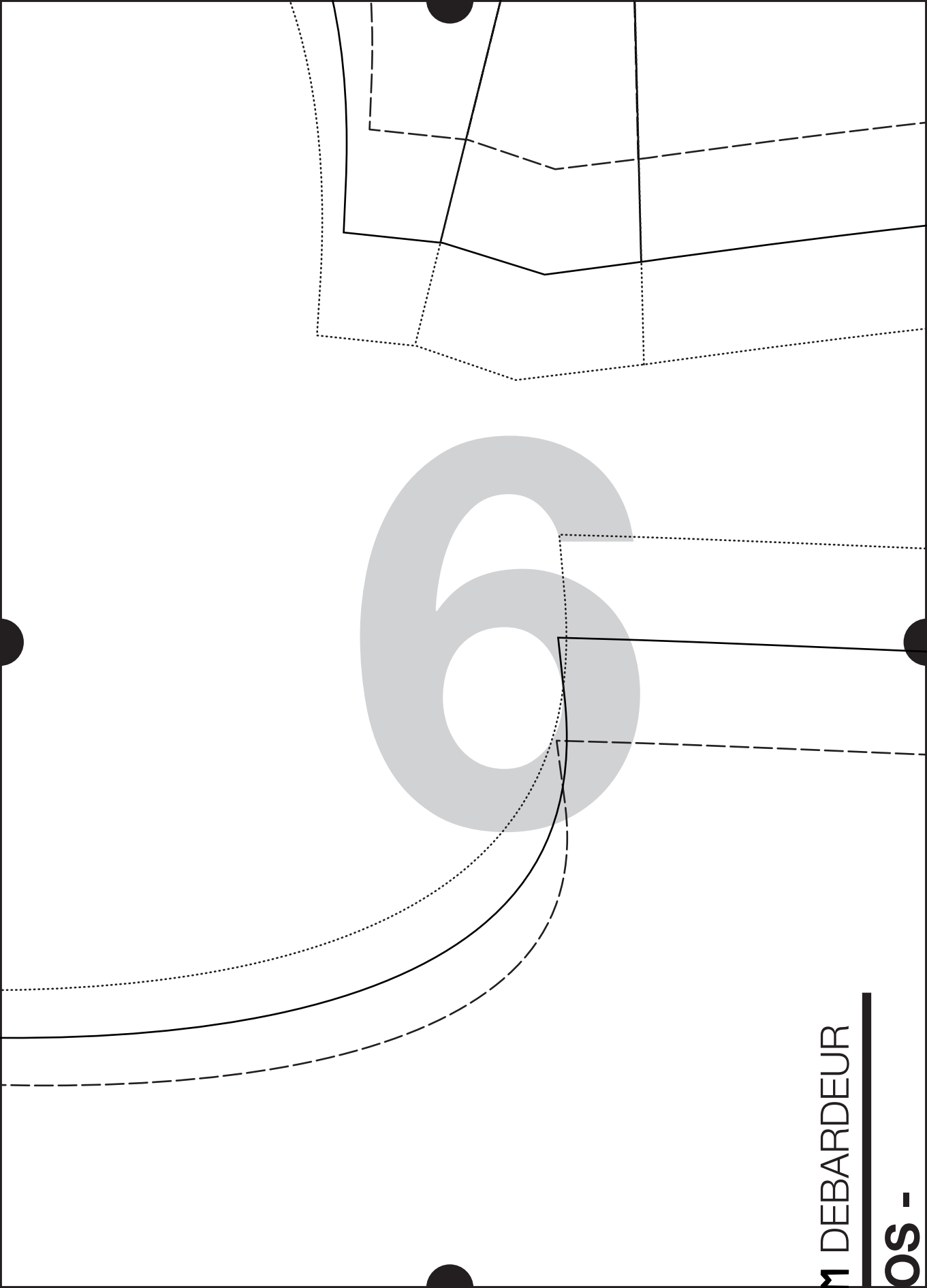

M DEBARDEUR

OS -

ACK

paper X 1 au pli - cut x 1 on fold

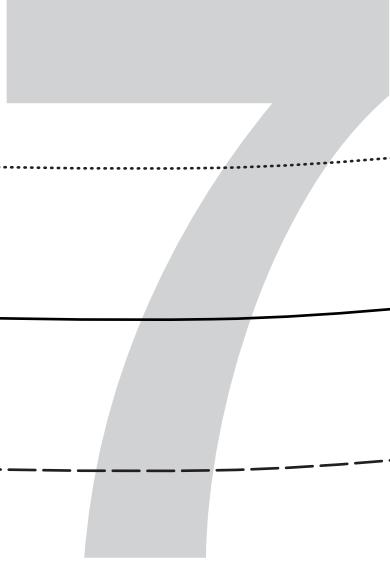

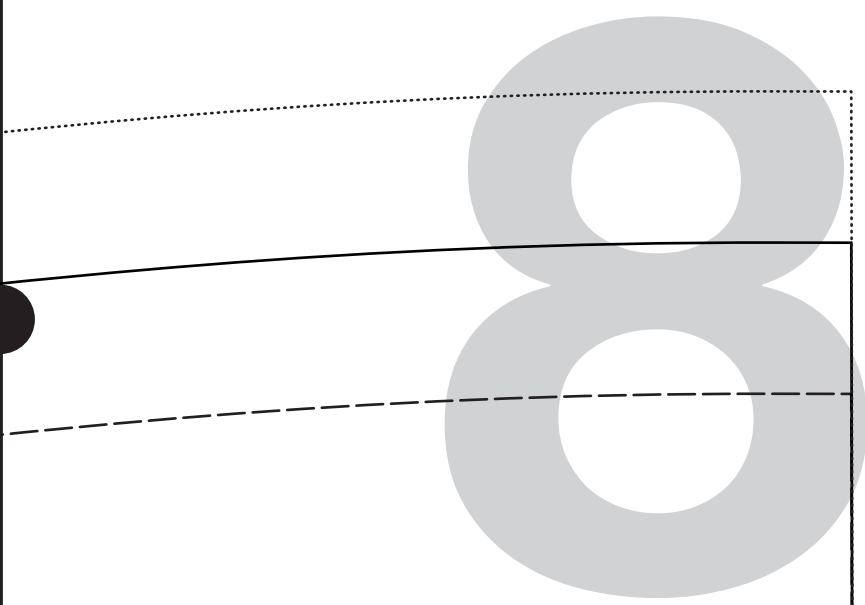
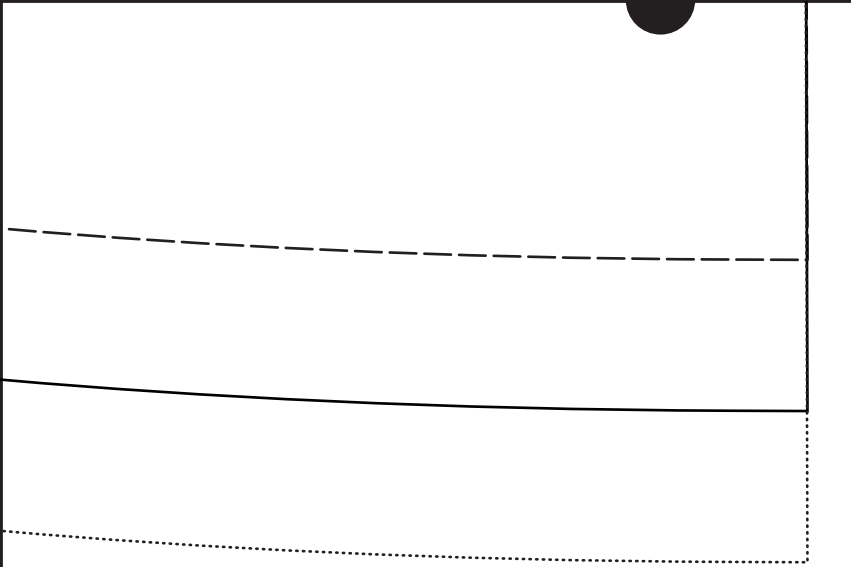

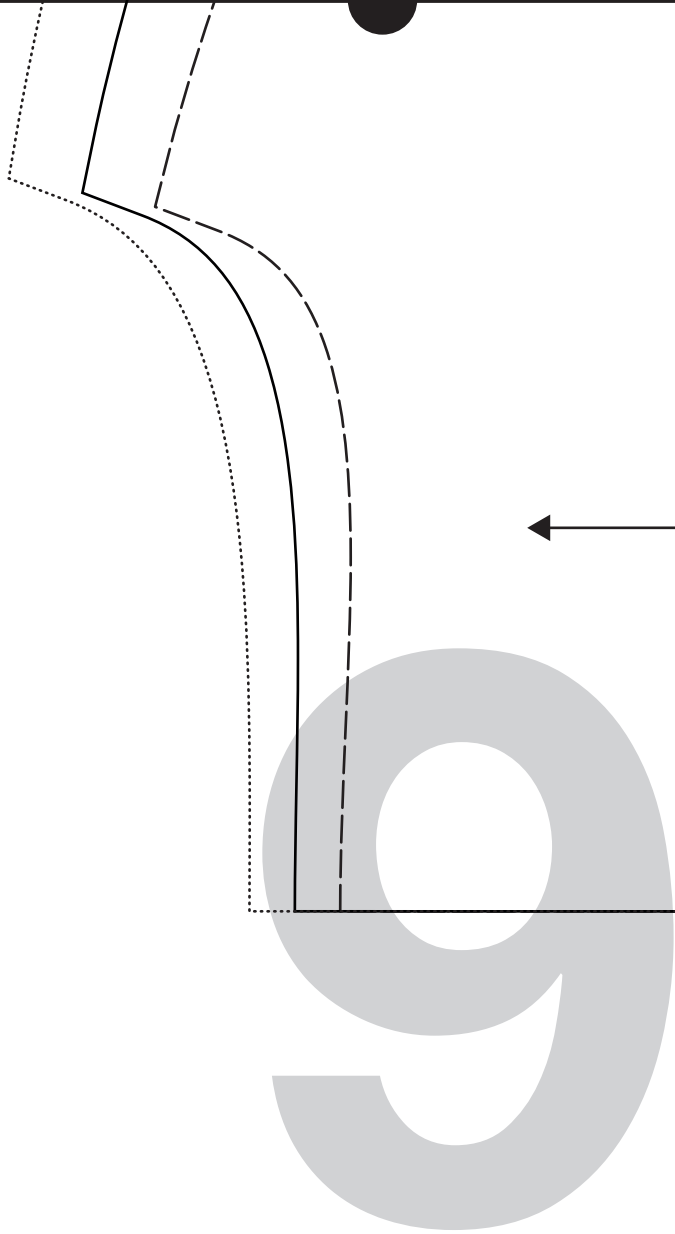

GRAIN LINE

10

MIL DOS AU PLI - CEN





DROIT FIL

ATER BACK ON FOLD

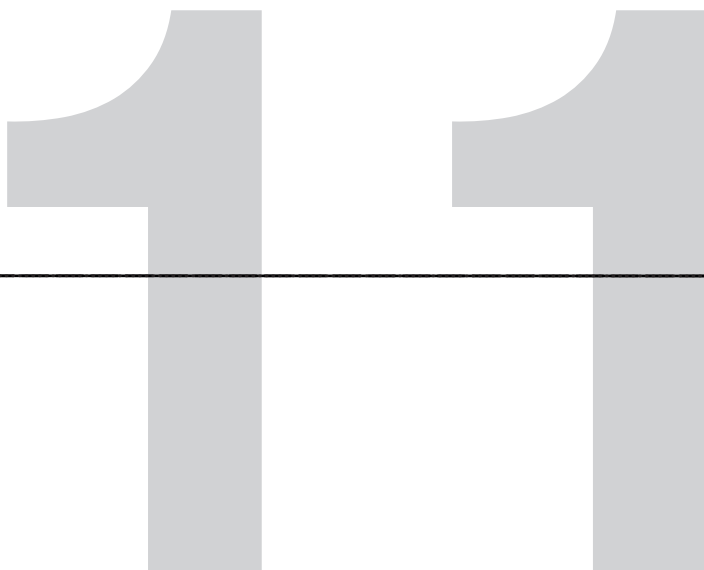

12

