

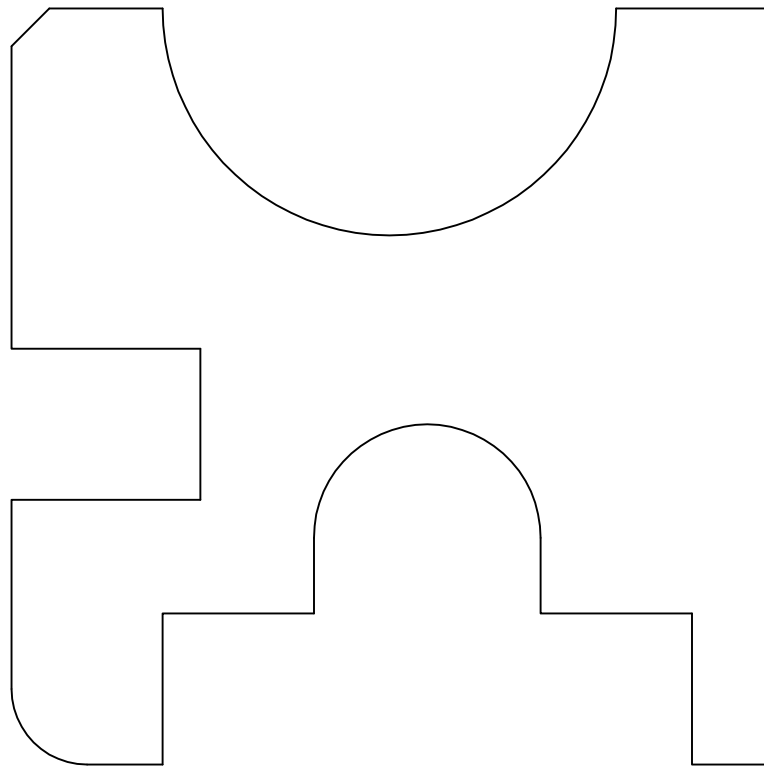

Acota la figura plana.



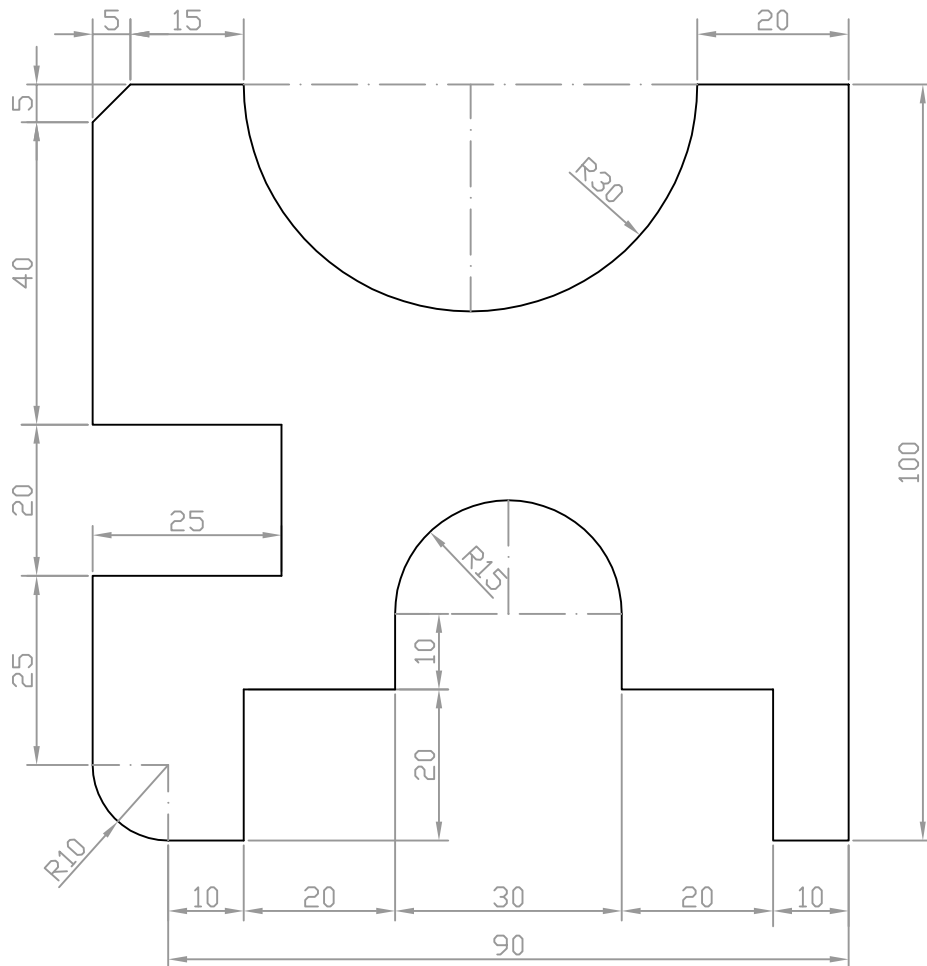

Escala 1:1	Fecha	Nombre	 Col·legi Mestral
Dibujado	03/04/2012	Carlos Riera Planells	
Comprobado	03/04/2012	Carlos Riera Planells	
 Dibujos Técnicos www.dibujotecnico.info	ACOTACIÓN		ACOTACIÓN-1
			Bachillerato

Acota la figura plana.



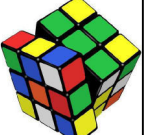

Cotas en mm

Escala 1:1	Fecha	Nombre		
Dibujado	03/04/2012	Carlos Riera Planells		
Comprobado	03/04/2012	Carlos Riera Planells		
	DiBuJo TÉCNICO www.dibujotecnico.info	<h1>ACOTACIÓN</h1>		ACOTACIÓN-1
				Bachillerato

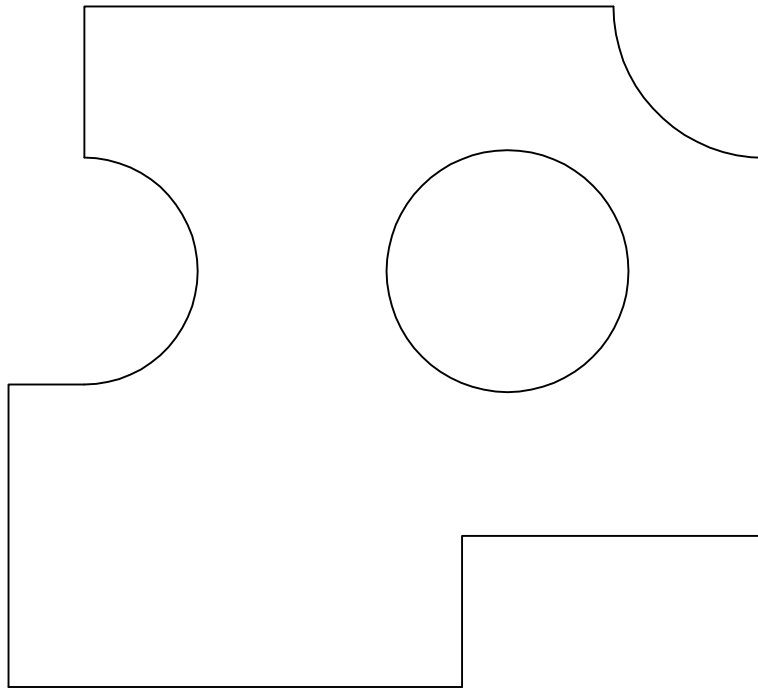
Acota la figura plana.



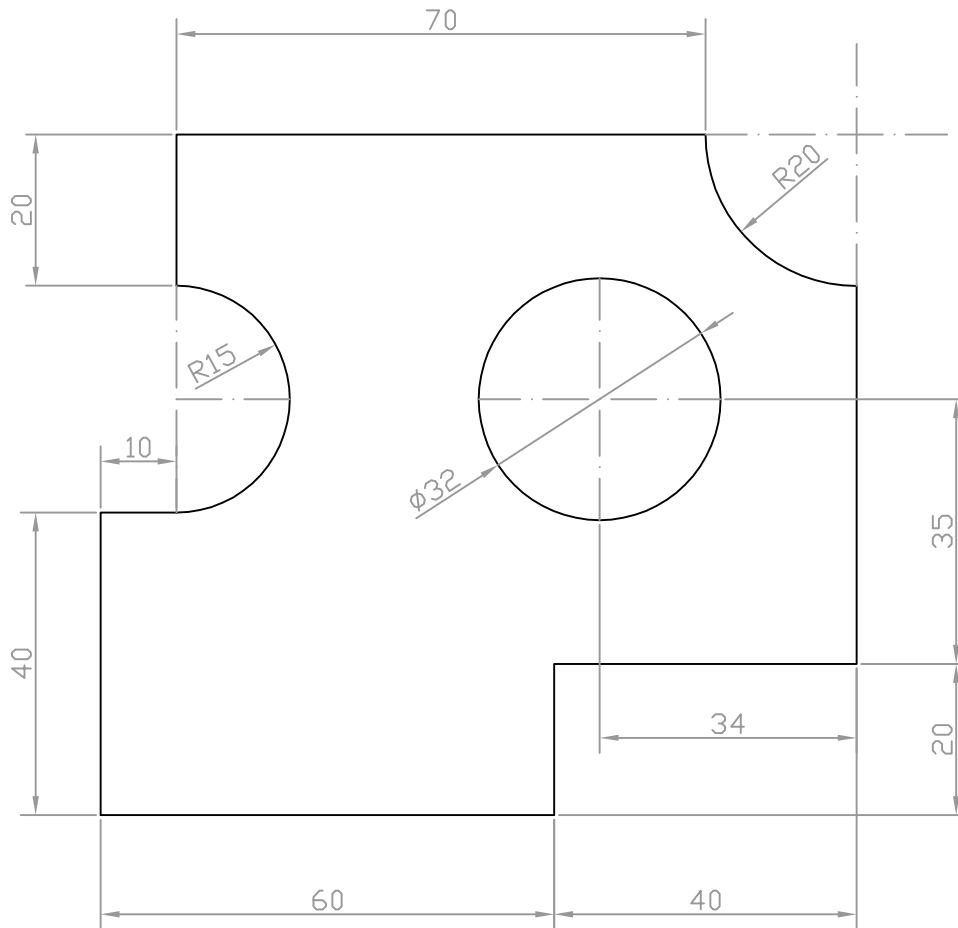

Escala 1:1	Fecha	Nombre	
Dibujado	03/04/2012	Carlos Riera Planells	
Comprobado	03/04/2012	Carlos Riera Planells	
 Dibujo Técnico www.dibujotecnico.info	ACOTACIÓN		ACOTACIÓN-2
			Bachillerato

Acota la figura plana.



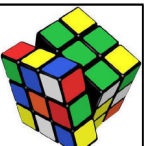

Cotas en mm

Escala 1:1	Fecha	Nombre		
Dibujado	03/04/2012	Carlos Riera Planells		
Comprobado	03/04/2012	Carlos Riera Planells		
	DiBuJo TÉCNICO www.dibujotecnico.info	ACOTACIÓN		ACOTACIÓN-2
				Bachillerato

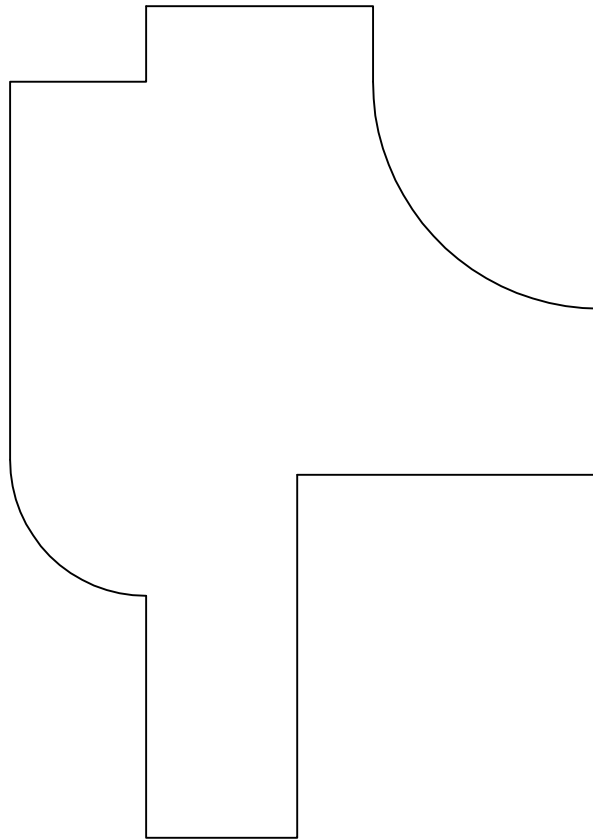
Acota la figura plana.



Escala 1:1	Fecha	Nombre	 Col·legi Mestral
Dibujado	03/04/2012	Carlos Riera Planells	
Comprobado	03/04/2012	Carlos Riera Planells	
 Dibujos Técnicos www.dibujotecnico.info	ACOTACIÓN		ACOTACIÓN-3
			Bachillerato

Acota la figura plana.

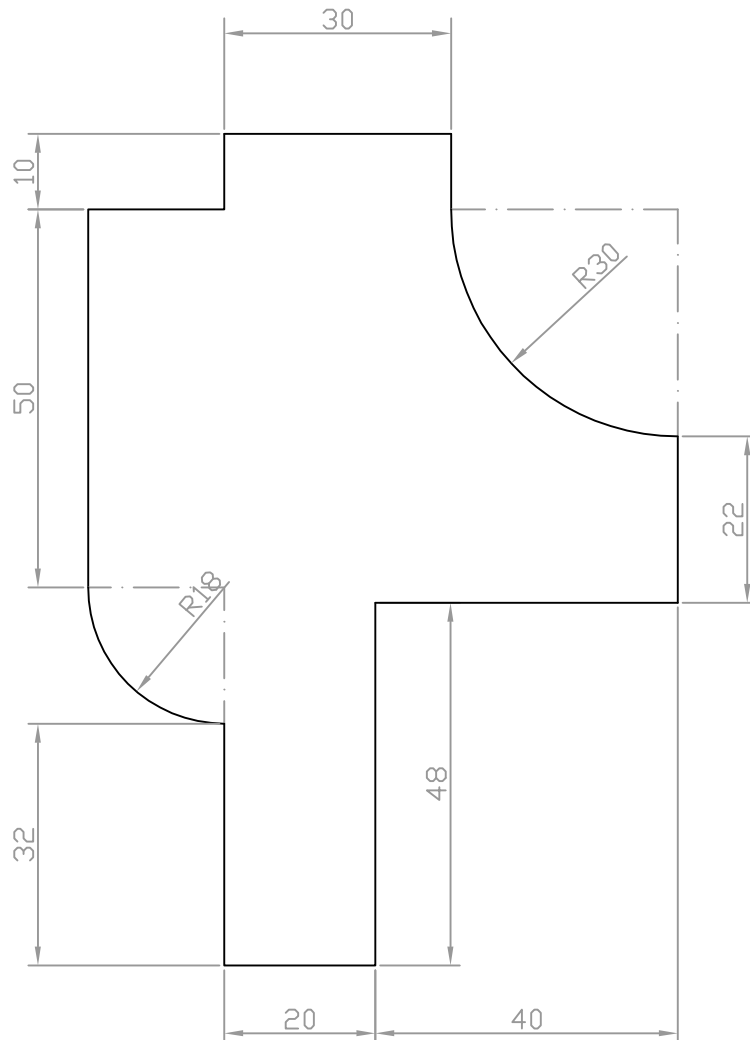



Cotas en mm

Escala 1:1	Fecha	Nombre		
Dibujado	03/04/2012	Carlos Riera Planells		
Comprobado	03/04/2012	Carlos Riera Planells		
	DiBuJo TÉCNiCo www.dibujotecnico.info	ACOTACIÓN		ACOTACIÓN-3
				Bachillerato

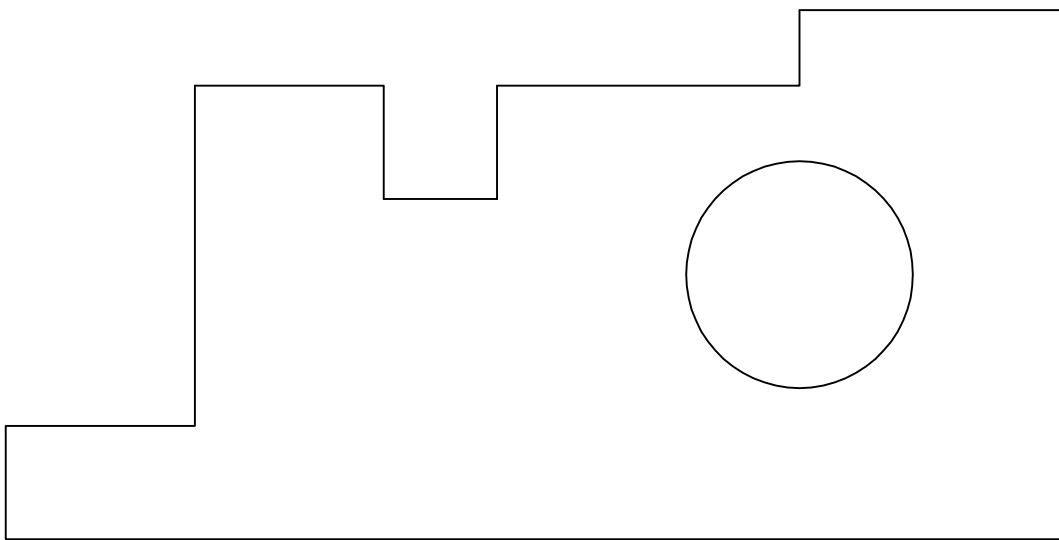
Acota la figura plana.





Escala 1:1	Fecha	Nombre	
Dibujado	03/04/2012	Carlos Riera Planells	
Comprobado	03/04/2012	Carlos Riera Planells	
	Dibujo Técnico www.dibujotecnico.info		ACOGACIÓN-4
			Bachillerato

ACOTACIÓN

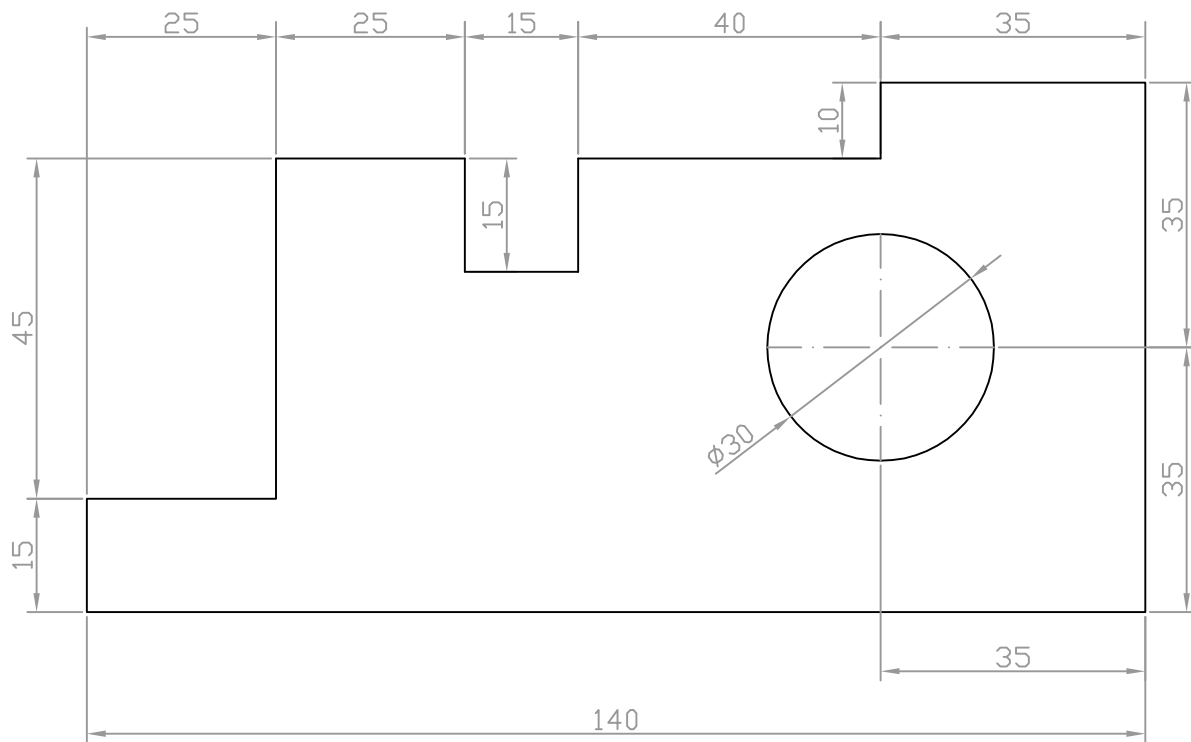
Acota la figura plana.



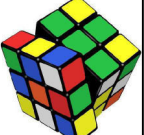

Cotas en mm

Escala 1:1	Fecha	Nombre		
Dibujado	03/04/2012	Carlos Riera Planells		
Comprobado	03/04/2012	Carlos Riera Planells		
	DiBuJo TÉCNiCo www.dibujotecnico.info	<h1>ACOTACIÓN</h1>		ACOGACIÓN-4
				Bachillerato

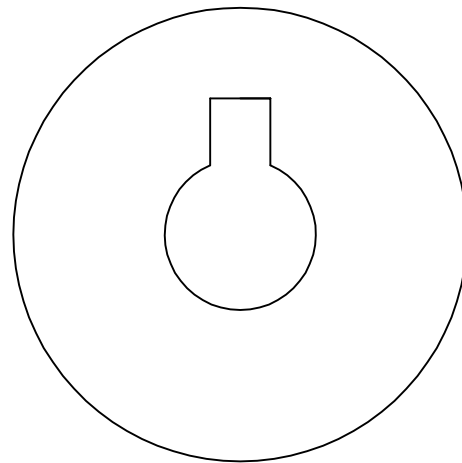
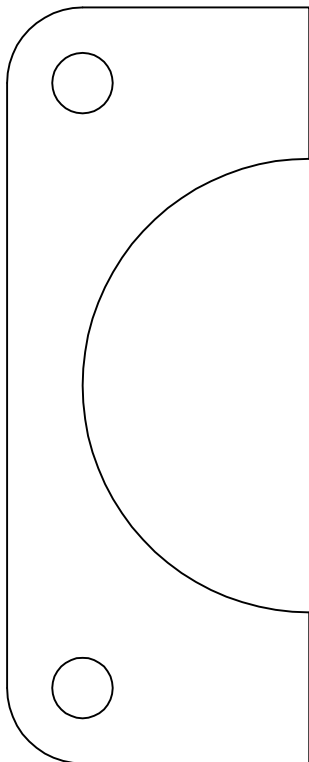
Acotar las siguientes figuras planas.



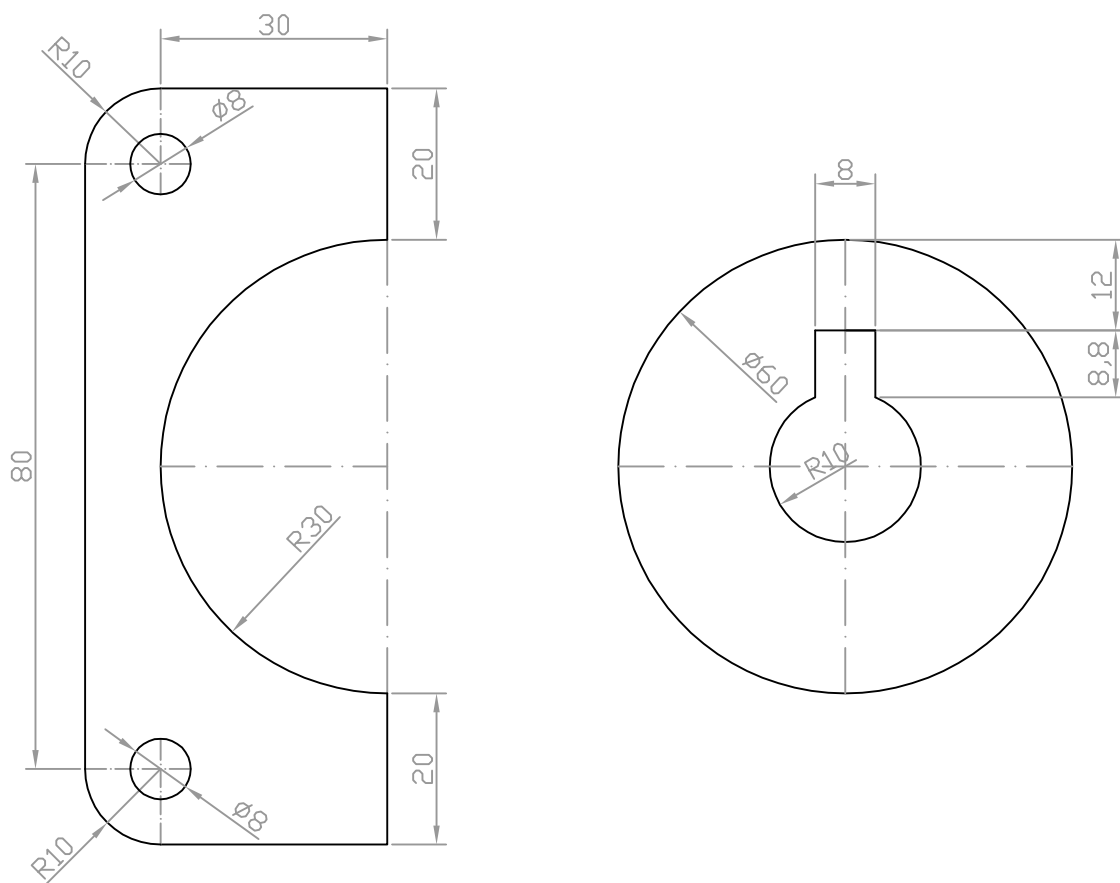

Escala 1:1	Fecha	Nombre	
Dibujado	03/04/2012	Carlos Riera Planells	
Comprobado	03/04/2012	Carlos Riera Planells	
	Dibujo Técnico www.dibujotecnico.info	ACOTACIÓN	
		ACOTACIÓN-5	
		Bachillerato	

Acotar las siguientes figuras planas.



Cotas en mm

Escala 1:1	Fecha	Nombre	
Dibujado	03/04/2012	Carlos Riera Planells	
Comprobado	03/04/2012	Carlos Riera Planells	
		<p>Dibujos Técnicos www.dibujotecnico.info</p>	
<h2>ACOTACIÓN</h2>			<p>ACOTACIÓN-5</p> <p>Bachillerato</p>